

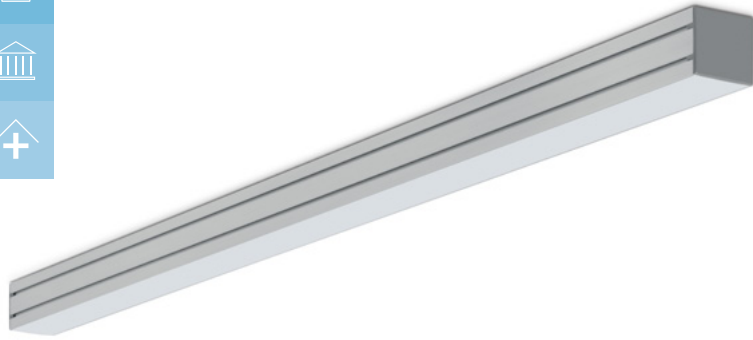

# ARES LED 1.0



## Przewagi

- markowy zasilacz
- oprawa z aluminium malowanego proszkowo
- 3 systemy mocowania
- dostępność 3 opcji kolorystycznych: biały, czarny oraz dowolny z grupy RAL zgodnie z zamówieniem



### Ares LED 1.0 1

ARS1ST.10.012.8A3000	12	800	3000K	>80	42	100°	0,9kg
ARS1ST.10.012.8A4000	12	850	4000K	>80	42	100°	0,9kg

### Ares LED 1.0 2

ARS1ST.20.016.8A3000	16	1200	3000K	>80	42	100°	1,2kg
ARS1ST.20.016.8A4000	16	1250	4000K	>80	42	100°	1,2kg

### Ares LED 1.0 3









ARS1ST.30.020.8A3000	20	1600	3000K	>80	42	100°	1,5kg
ARS1ST.30.020.8A4000	20	1650	4000K	>80	42	100°	1,5kg

### Ares LED 1.0 4









ARS1ST.40.025.8A3000	20	1950	3000K	>80	42	100°	1,8kg
ARS1ST.40.025.8A4000	20	2050	4000K	>80	42	100°	1,8kg

W celu zapoznania się z parametrami świetlnymi, dla danego kąta rozsytu światłości prosimy o postępowanie się plikami fotometrycznymi. Link do pobrania: [luxon.pl/Pliki/LDT-LUXON-LED-2020.zip](http://luxon.pl/Pliki/LDT-LUXON-LED-2020.zip)









### Ares LED 1.0 5

							
ARS1ST.50.029.8A3000	29	2350	3000K	>80	42	100°	2,1kg
ARS1ST.50.029.8A4000	29	2450	4000K	>80	42	100°	2,1kg









### Ares LED 1.0 6

							
ARS1ST.60.033.8A3000	33	2750	3000K	>80	42	100°	2,4kg
ARS1ST.60.033.8A4000	33	2850	4000K	>80	42	100°	2,4kg









### Ares LED 1.0 7

							
ARS1ST.70.037.8A3000	37	3150	3000K	>80	42	100°	2,7kg
ARS1ST.70.037.8A4000	37	3300	4000K	>80	42	100°	2,7kg

### Ares LED 1.0 8

							
ARS1ST.80.041.8A3000	41	3550	3000K	>80	42	100°	3kg
ARS1ST.80.041.8A4000	41	3700	4000K	>80	42	100°	3kg

### Ares LED 1.0 9

							
ARS1ST.90.045.8A3000	45	3950	3000K	>80	42	100°	3,3kg
ARS1ST.90.045.8A4000	45	4100	4000K	>80	42	100°	3,3kg

## Wymiarowanie i Logistyka

	H	L	W
ARS1ST.1	50	400	50
ARS1ST.2	50	600	50
ARS1ST.3	50	800	50
ARS1ST.4	50	1000	50
ARS1ST.5	50	1200	50
ARS1ST.6	50	1400	50
ARS1ST.7	50	1600	50
ARS1ST.8	50	1800	50
ARS1ST.9	50	2000	50

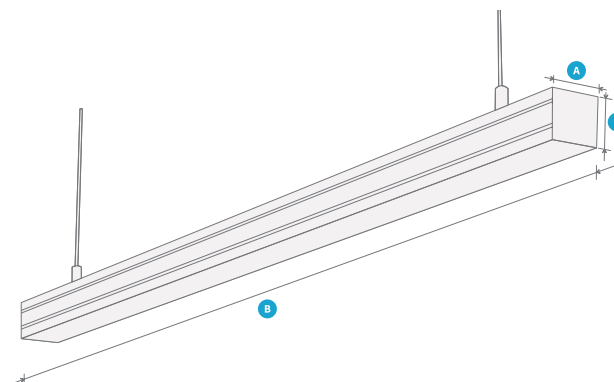

## Montaż

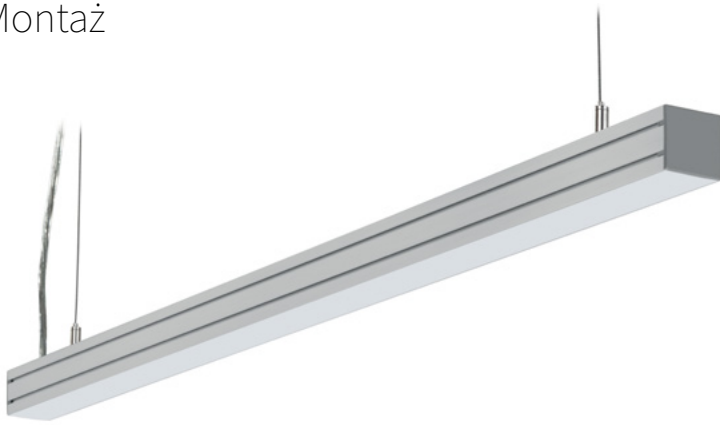

**montaż zwieszany**

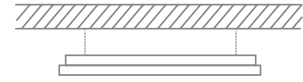

## Rozsył Światłości

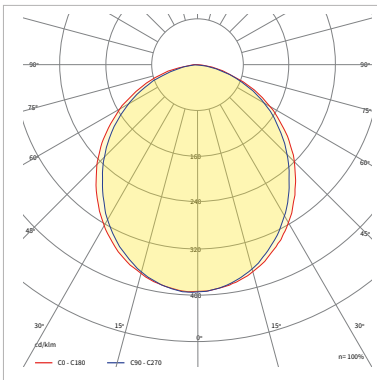

## Dostępne konfiguracje

Rodzina	Wersja mocowa	Wersja	Moc [W]	CRI	Typ diody	CCT [K]	Materiał soczewki	Materiał dyfuzora	Rozsył	Sterowanie	Temperatury pracy [°C]	Gwarancja	Modyfikacje
ARS1ST ARES LED 1	1	0 Standard	012	8 >80	A Mid Power	3000	0 Nie występuje	P23 PC Matowe	100100 100°x100°	00	2040	05Y 5 lat	0000 Standard
	1		12W			3000K				00 ON/OFF			
	2		016			4000				D0			
	2		16W			4000K				D0 Dali Przewodowe			
	3		020										
	3		20W										
	4		025										
	4		25W										
	5		029										
5	29W												
6	033												
6	33W												
7	037												
7	37W												
8	041												
8	41W												
9	045												
9	45W												

Przykładowy kod produktu:

ARS1ST.20.016.8A4000.0P23.100100.D0.2040.05Y.0000