



DRAFT LED 1.0

Vorteile

- Schutzart IP65
- Schnelle und einfache Montage
- Niedrige UGR-Faktoren
- Mehrere Montagevarianten
- Möglichkeit einer beliebigen Richtung des Lichtstrahls



Draft Led 1.0 1

| | | min-max | | | | | |
|----------------------|----|---------------|-------|-----|----|-----------------------------|-------|
| DRF1ST.10.067.8A3000 | 67 | 10300 - 10450 | 3000K | >80 | 65 | 50°X50°, 80°X80°, 110°X110° | 2,3kg |
| DRF1ST.10.067.8A4000 | 67 | 11250 - 11400 | 4000K | >80 | 65 | 50°X50°, 80°X80°, 110°X110° | 2,3kg |
| DRF1ST.10.067.8A5000 | 67 | 11300 - 11450 | 5000K | >80 | 65 | 50°X50°, 80°X80°, 110°X110° | 2,3kg |









Draft Led 1.0 2

| | | min-max | | | | | |
|----------------------|----|---------------|-------|-----|----|-----------------------------|-------|
| DRF1ST.20.086.8A3000 | 86 | 12950 - 13150 | 3000K | >80 | 65 | 50°X50°, 80°X80°, 110°X110° | 2,3kg |
| DRF1ST.20.086.8A4000 | 86 | 14100 - 14350 | 4000K | >80 | 65 | 50°X50°, 80°X80°, 110°X110° | 2,3kg |
| DRF1ST.20.086.8A5000 | 86 | 14150 - 14400 | 5000K | >80 | 65 | 50°X50°, 80°X80°, 110°X110° | 2,3kg |

Draft Led 1.0 3

| | | min-max | | | | | |
|----------------------|-----|---------------|-------|-----|----|-----------------------------|-------|
| DRF1ST.30.115.8A3000 | 115 | 16700 - 16950 | 3000K | >80 | 65 | 50°X50°, 80°X80°, 110°X110° | 2,3kg |
| DRF1ST.30.115.8A4000 | 115 | 18200 - 18500 | 4000K | >80 | 65 | 50°X50°, 80°X80°, 110°X110° | 2,3kg |
| DRF1ST.30.115.8A5000 | 115 | 18250 - 18550 | 5000K | >80 | 65 | 50°X50°, 80°X80°, 110°X110° | 2,3kg |

Draft Led 1.0 4

|  |  |  -min-max |  |  |  |  |  |
|---|---|--|---|---|--|---|---|
| DRF1ST.40.134.8A3000 | 134 | 19050 - 19300 | 3000K | >80 | 65 | 50°X50°, 80°X80°, 110°X110° | 2,3kg |
| DRF1ST.40.134.8A4000 | 134 | 20750 - 21050 | 4000K | >80 | 65 | 50°X50°, 80°X80°, 110°X110° | 2,3kg |
| DRF1ST.40.134.8A5000 | 134 | 20800 - 21100 | 5000K | >80 | 65 | 50°X50°, 80°X80°, 110°X110° | 2,3kg |

Abmessungen und Logistik

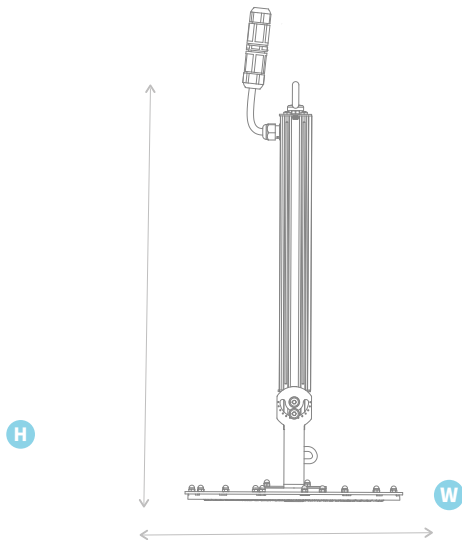

|  | H | W |
|---|---------------|-----|
| DRF1ST.1 | 560 | 270 |
| DRF1ST.2 | 560 | 270 |
| DRF1ST.3 | 560/640(DALI) | 270 |
| DRF1ST.4 | 560/640(DALI) | 270 |

Montageart

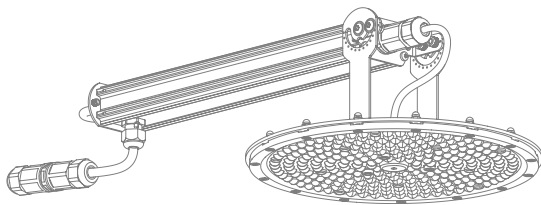

Deckenaufbau

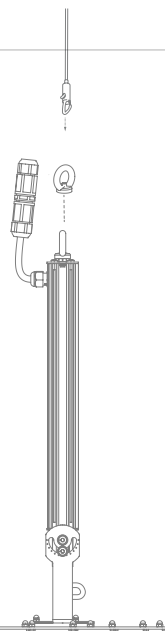

Seilabhängung



Lichtstärke

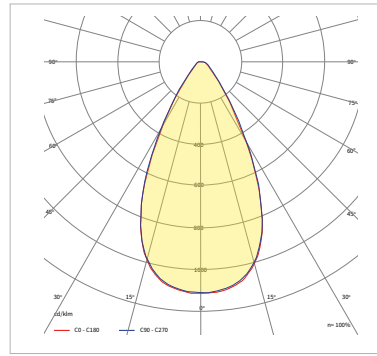
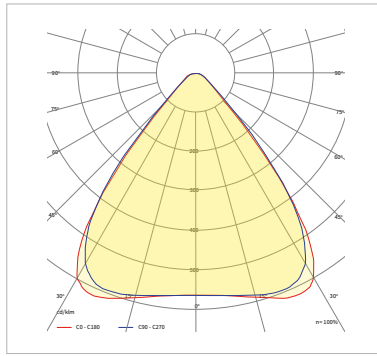
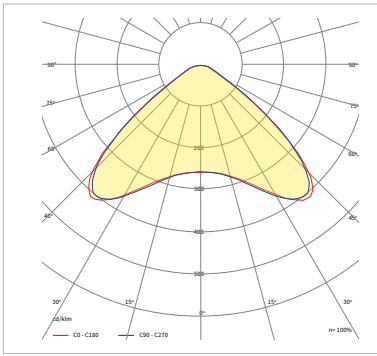

Verfügbare Konfigurationen

| Familie | Leistungs- version | Zertifikat | Nennleistung [W] | CRI | Typ der Diode | CCT [K] | Material der Linse | Material des Diffusors | Abstrahl- winkel | Lichtsteu- erung | Betriebstem- peratur [°C] | Garantie | Modifika- tionen | |
|----------------------------|-----------------------|---------------|---------------------|----------|------------------|---------|-----------------------|---------------------------|---------------------|---------------------|------------------------------|----------------|---------------------|--------|
| DRF1ST DRAFT LED 1.0 | 1 | 0 Standard | 067 | 8 >80 | A Mid Power | 3000 | 2 PC | 000 Keine Diffusor | 050050 | 00 ON/OFF | 2545 | 05Y 5 Jahre | 0000 Standard | |
| | 1 | | 67W | | | 3000K | | | 50°x50° | | -25÷45 | | | |
| | 2 | | 086 | | | 4000 | | | 080080 | | D0 DALI | | | 2550 |
| | 2 | | 86W | | | 4000K | | | 80°x80° | | | | | -25÷50 |
| 3 | 115 | 5000 | 110110 | 2555 | | | | | | | | | | |
| 3 | 115W | 5000K | 110°x110° | -20÷55 | | | | | | | | | | |
| 4 | 134 | | | | | | | | | | | | | |
| 4 | 134W | | | | | | | | | | | | | |

Beispiel-Produktcode:

[DRF1ST.10.067.8A4000.2000.080080.00.2555.05Y.0000](#)