



DRAFT LED 1.0

Advantages

- Protection class at the level of IP65
- Quick and easy installation
- Low UGR coefficients
- Several mounting options
- Ability to direct the light beam as desired



Draft Led 1.0 1

DRF1ST.10.067.8A3000	67	10300 - 10450	3000K	>80	65	50°X50°, 80°X80°, 110°X110°	2,3kg
DRF1ST.10.067.8A4000	67	11250 - 11400	4000K	>80	65	50°X50°, 80°X80°, 110°X110°	2,3kg
DRF1ST.10.067.8A5000	67	11300 - 11450	5000K	>80	65	50°X50°, 80°X80°, 110°X110°	2,3kg









Draft Led 1.0 2

DRF1ST.20.086.8A3000	86	12950 - 13150	3000K	>80	65	50°X50°, 80°X80°, 110°X110°	2,3kg
DRF1ST.20.086.8A4000	86	14100 - 14350	4000K	>80	65	50°X50°, 80°X80°, 110°X110°	2,3kg
DRF1ST.20.086.8A5000	86	14150 - 14400	5000K	>80	65	50°X50°, 80°X80°, 110°X110°	2,3kg

Draft Led 1.0 3

DRF1ST.30.115.8A3000	115	16700 - 16950	3000K	>80	65	50°X50°, 80°X80°, 110°X110°	2,3kg
DRF1ST.30.115.8A4000	115	18200 - 18500	4000K	>80	65	50°X50°, 80°X80°, 110°X110°	2,3kg
DRF1ST.30.115.8A5000	115	18250 - 18550	5000K	>80	65	50°X50°, 80°X80°, 110°X110°	2,3kg

Draft Led 1.0 4

		 -min-max					
DRF1ST.40.134.8A3000	134	19050 - 19300	3000K	>80	65	50°X50°, 80°X80°, 110°X110°	2,3kg
DRF1ST.40.134.8A4000	134	20750 - 21050	4000K	>80	65	50°X50°, 80°X80°, 110°X110°	2,3kg
DRF1ST.40.134.8A5000	134	20800 - 21100	5000K	>80	65	50°X50°, 80°X80°, 110°X110°	2,3kg

Dimensions and Logistics

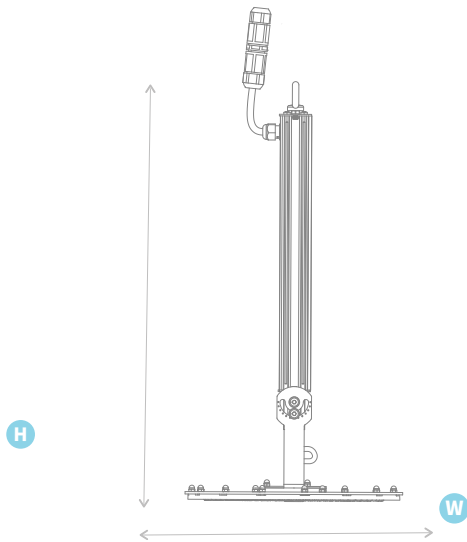

	H	W
DRF1ST.1	560	270
DRF1ST.2	560	270
DRF1ST.3	560/640(DALI)	270
DRF1ST.4	560/640(DALI)	270

Montage

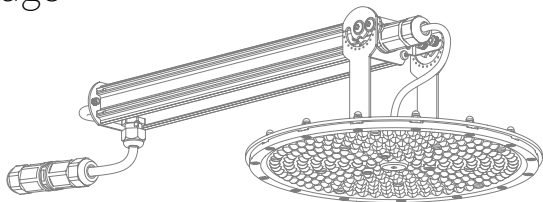

surface mounting

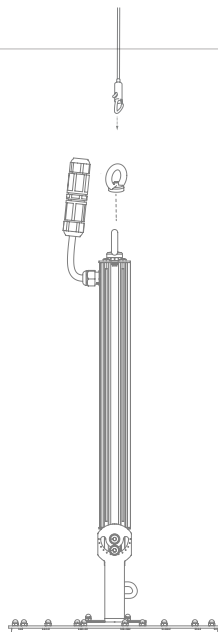
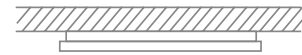

suspended

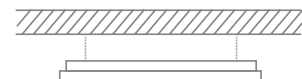

Luminous Intensity Distribution

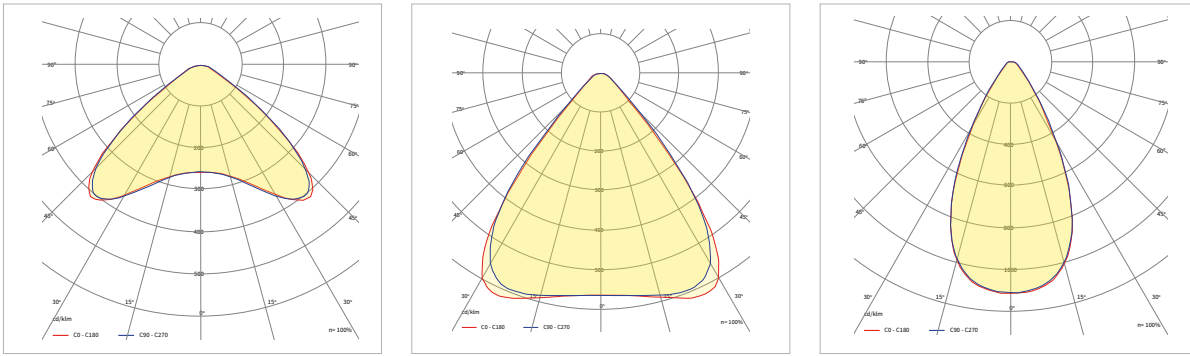

Available Configurations

Family	Power version	Certificate	Power [W]	CRI	Diode type	CCT [K]	Lens material	Diffuser material	Beam angle	Type of control	Operating temperature[°C]	Warranty	Modifications
DRF1ST DRAFT LED 1.0	1	0 Standard	067	8 >80	A Mid Power	3000	2 PC	000 No diffuser	050050	00 ON/OFF	2545	05Y 5 years	0000 Standard
	1		67W			3000K			50°x50°		-25÷45		
	2		086			4000			080080		2550		
	2		86W			4000K			80°x80°		-25÷50		
3	115	5000	110110	2555									
3	115W	5000K	110°x110°	-20÷55									
4	134												
4	134W												

Example product code:

[DRF1ST.10.067.8A4000.2000.080080.00.2555.05Y.0000](#)