



DRAFT LED 1.0

Przewagi

- Stopień szczelności na poziomie IP65
- Szybki i prosty montaż
- Niski współczynnik UGR
- Kilka wariantów montażu
- Możliwość dowolnego skierowania wiązki światła



Draft Led 1.0 1

		min-max					
DRF1ST.10.067.8A3000	67	10300 - 10450	3000K	>80	65	50°X50°, 80°X80°, 110°X110°	2,3kg
DRF1ST.10.067.8A4000	67	11250 - 11400	4000K	>80	65	50°X50°, 80°X80°, 110°X110°	2,3kg
DRF1ST.10.067.8A5000	67	11300 - 11450	5000K	>80	65	50°X50°, 80°X80°, 110°X110°	2,3kg









Draft Led 1.0 2

		min-max					
DRF1ST.20.086.8A3000	86	12950 - 13150	3000K	>80	65	50°X50°, 80°X80°, 110°X110°	2,3kg
DRF1ST.20.086.8A4000	86	14100 - 14350	4000K	>80	65	50°X50°, 80°X80°, 110°X110°	2,3kg
DRF1ST.20.086.8A5000	86	14150 - 14400	5000K	>80	65	50°X50°, 80°X80°, 110°X110°	2,3kg

Draft Led 1.0 3

		min-max					
DRF1ST.30.115.8A3000	115	16700 - 16950	3000K	>80	65	50°X50°, 80°X80°, 110°X110°	2,3kg
DRF1ST.30.115.8A4000	115	18200 - 18500	4000K	>80	65	50°X50°, 80°X80°, 110°X110°	2,3kg
DRF1ST.30.115.8A5000	115	18250 - 18550	5000K	>80	65	50°X50°, 80°X80°, 110°X110°	2,3kg

Draft Led 1.0 4

		 lm-min-max					
DRF1ST.40.134.8A3000	134	19050 - 19300	3000K	>80	65	50°X50°, 80°X80°, 110°X110°	2,3kg
DRF1ST.40.134.8A4000	134	20750 - 21050	4000K	>80	65	50°X50°, 80°X80°, 110°X110°	2,3kg
DRF1ST.40.134.8A5000	134	20800 - 21100	5000K	>80	65	50°X50°, 80°X80°, 110°X110°	2,3kg

Wymiarowanie i Logistyka

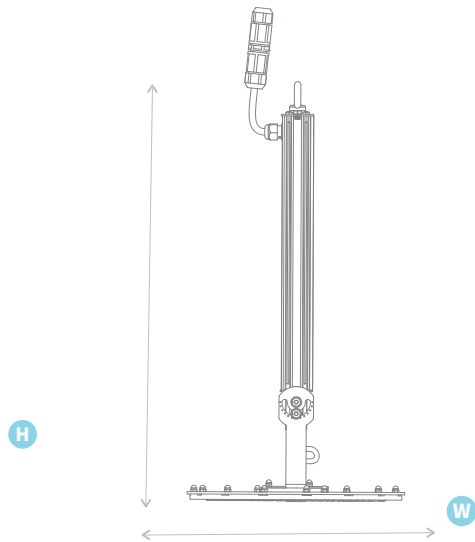

	H	W
DRF1ST.1	560	270
DRF1ST.2	560	270
DRF1ST.3	560/640(DALI)	270
DRF1ST.4	560/640(DALI)	270

Montaż

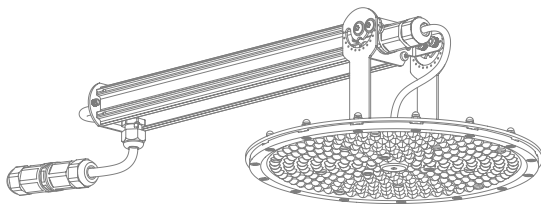

natynkowy

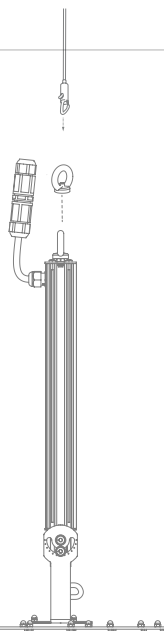

zwieszany



Rozsył światłości

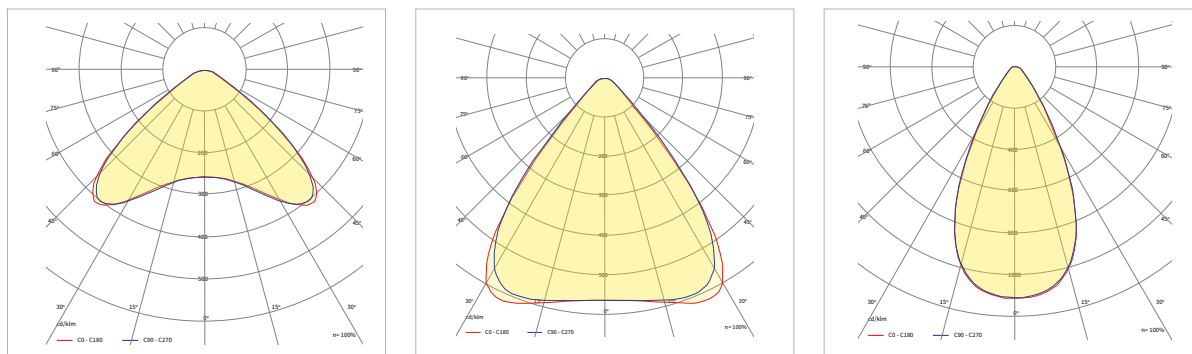

Dostępne konfiguracje

Rodzina	Wersja mocowa	Wersja	Moc [W]	CRI	Typ diody	CCT [K]	Materiał soczewki	Materiał dyfuzora	Rozsył	Sterowanie	Temperatury pracy [°C]	Gwarancja	Modyfikacje
DRF1ST DRAFT LED 1.0	1	0	067	8	A	3000	2	000	050050	00	2545	05Y	0000
	1	Standard	67W	>80	Mid Power	3000K	PC	Nie występuje	50x50	ON/OFF	-25÷45	5 lat	Standard
	2		086			4000			080080	D0	2550		
	2		86W			4000K			80x80	Dali Przewodowe	-25÷50		
	3		115			5000			110110		2555		
	3		115W			5000K			110x110		-20÷55		
	4		134										
	4		134W										

Przykładowy kod produktu:

[DRF1ST.10.067.8A4000.2000.080080.00.2555.05Y.0000](#)