



Industrial LED DE 6.0



Vorteile

- Hohe Lichtausbeute von bis zu 180 Lm/W
- IP66 Leuchte
- Schnelle und einfache Montage
- Markenkomponenten
- Bis zu 10 Jahre Garantie
- hoher Temperaturbereich



Industrial LED 6.0 1





| IND6DE.10.026.8A3000 | 26 | 4250 | 3000K | >80 | IP 66 | 120°X110° | 2,4 kg |
|----------------------|----|------|-------|-----|-------|-----------|--------|
| IND6DE.10.026.8A4000 | 26 | 4400 | 4000K | >80 | IP 66 | 120°X110° | 2,4 kg |
| IND6DE.10.026.8A5000 | 26 | 4450 | 5000K | >80 | IP 66 | 120°X110° | 2,4 kg |

Industrial LED 6.0 2

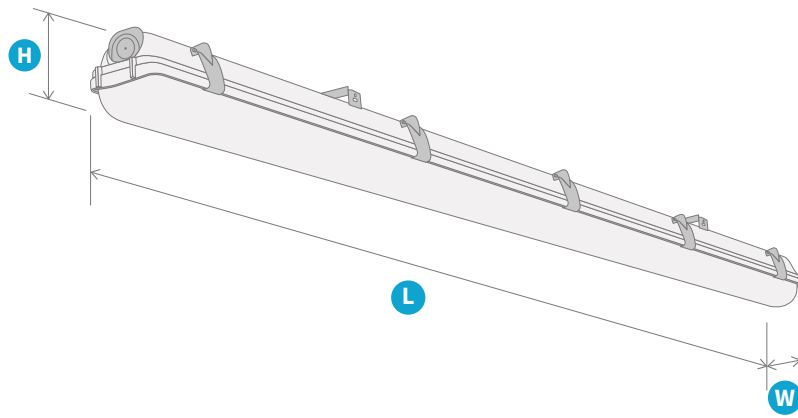
| IND6DE.20.043.8A3000 | 43 | 7100 | 3000K | >80 | IP 66 | 120°X110° | 2,4 kg |
|----------------------|----|------|-------|-----|-------|-----------|--------|
| IND6DE.20.043.8A4000 | 43 | 7300 | 4000K | >80 | IP 66 | 120°X110° | 2,4 kg |
| IND6DE.20.043.8A5000 | 43 | 7350 | 5000K | >80 | IP 66 | 120°X110° | 2,4 kg |

Abmessungen und Logistik



|  | H | L | W |  |  |  |  |
|-----------------------------------------------------------------------------------|----|------|----|-----------------------------------------------------------------------------------|-------------------------------------------------------------------------------------|-------------------------------------------------------------------------------------|-------------------------------------------------------------------------------------|
| IND6DE.1 | 80 | 1573 | 97 | IND6DE.1 | 10 | 100 | 160x80 |
| IND6DE.2 | 80 | 1573 | 97 | IND6DE.2 | 10 | 100 | 160x80 |

Montageart



Lichtstärke

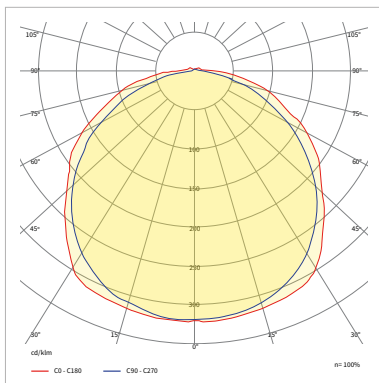

Verfügbare Konfigurationen

| Familie | Leistungs- version | Version | Nennleistung [W] | CRI | Typ der Diode | CCT [K] | Material der Linse | Material des Diffusors | Abstrahl- winkel | Lichtsteu- erung | Betriebstem- peratur [°C] | Garantie | Modifika- tionen |
|------------------------------------|-----------------------|---------------|---------------------|----------|------------------|---------------------|-----------------------|---------------------------|---------------------|---------------------|------------------------------|----------------|--------------------------------------------------|
| IND6DE Industrial LED DE 6.0 | 1 | 0 Standard | 026 | 8 >80 | A Mid Power | 3000 | 0 Keine Linse | P21 PC Transparent | 120°x110° | 00 | 0030 | 05Y 5 Jahre | 0000 Standard |
| | 1 | | 26W | | | 3000K | | | | ON/OFF | -30÷50 | | |
| | 2 | 2 | 043 | 4000 | | 4000K 5000K | | | | D0 | 2540 | 08Y | E001 |
| | | | 43W | 4000K | | | | | | DALI | -25÷40 | 8 Jahre | Durchgan- gsversion |
| | 2 | 2 | 43W | 5000 | | | | | | 5000K | E3 | 2545 | 10Y |
| | | | | 5000K | | Notfall Modul 3h | | | | | -25÷45 | 10 Jahre | Durchgan- gsversion; Schnellan- schluss |
| | | | | | | 2550 | | | | | | | |
| | | | | | | 2555 | | | | | | | E010 Schnellan- schluss |

Beispiel-Produktcode

IND6ST.28.042.8A4000.0P21.110110.D0.2540.05Y.0000