



# INDUSTRIAL LED 6.0 ENEC

## Przewagi

- Wysoka skuteczność świetlna do 180 lm/W
- Oprawa z IP66
- Klasa odporności IK08
- Wysoki zakres temperatury pracy



### Industrial LED 6.0 1

| IND6ST.18.032.8A3000 | 32 | 5450 | 3000K | >80 | IP 66 | 110° | 2kg |
|----------------------|----|------|-------|-----|-------|------|-----|
| IND6ST.18.032.8A4000 | 32 | 5650 | 4000K | >80 | IP 66 | 110° | 2kg |
| IND6ST.18.032.8A5000 | 32 | 5700 | 5000K | >80 | IP 66 | 110° | 2kg |

### Industrial LED 6.0 2









| IND6ST.28.042.8A3000 | 42 | 7200 | 3000K | >80 | IP 66 | 110° | 2kg |
|----------------------|----|------|-------|-----|-------|------|-----|
| IND6ST.28.042.8A4000 | 42 | 7450 | 4000K | >80 | IP 66 | 110° | 2kg |
| IND6ST.28.042.8A5000 | 42 | 7500 | 5000K | >80 | IP 66 | 110° | 2kg |

### Industrial LED 6.0 3

| IND6ST.38.066.8A3000 | 66 | 11500 | 3000K | >80 | IP 66 | 110° | 2,4kg |
|----------------------|----|-------|-------|-----|-------|------|-------|
| IND6ST.38.066.8A4000 | 66 | 11850 | 4000K | >80 | IP 66 | 110° | 2,4kg |
| IND6ST.38.066.8A5000 | 66 | 11900 | 5000K | >80 | IP 66 | 110° | 2,4kg |

W celu zapoznania się z parametrami świetlnymi, dla danego kąta rozsytu światłości prosimy o postępowanie się plikami fotometrycznymi. Link do pobrania: [luxon.pl/Pliki/LDT-LUXON-LED-2020.zip](http://luxon.pl/Pliki/LDT-LUXON-LED-2020.zip)



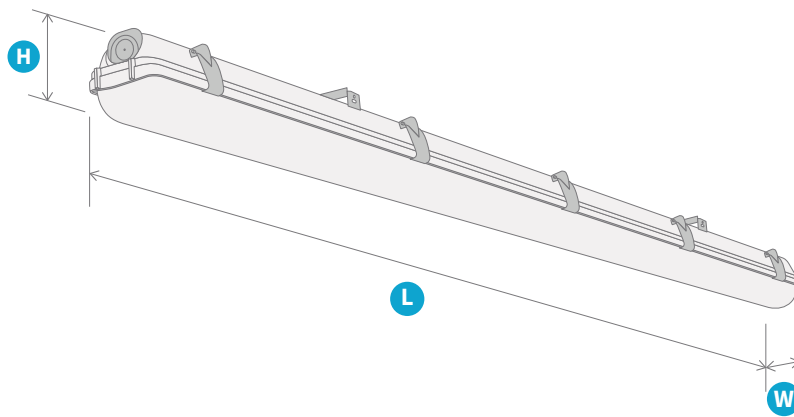

## Industrial LED 6.0 4

|  |  |  |  |  |  |  |  |
|---|---|---|---|---|--|---|---|
| IND6ST.48.097.8A3000  | 97  | 15300   | 3000K   | >80   | IP 66  | 110°  | 2,4kg   |
| IND6ST.48.097.8A4000  | 97  | 15800   | 4000K   | >80   | IP 66  | 110°  | 2,4kg   |
| IND6ST.48.097.8A5000  | 97  | 15850   | 5000K   | >80   | IP 66  | 110°  | 2,4kg   |

## Wymiarowanie i Logistyka



|  | H  | L    | W  |
|---|----|------|----|
| IND6ST 1  | 80 | 1277 | 97 |
| IND6ST 2  | 80 | 1277 | 97 |
| IND6ST 3  | 80 | 1573 | 97 |
| IND6ST 4  | 80 | 1573 | 97 |

|  |  |  |  |
|---|---|---|---|
| IND6ST 1  | 10  | 100   | 160x80  |
| IND6ST 2  | 10  | 100   | 160x80  |
| IND6ST 3  | 10  | 100   | 160x80  |
| IND6ST 4  | 10  | 100   | 160x80  |

## Montaż



**Montaż natynkowy**



**Montaż zwieszany**



# Rozsył Światłości

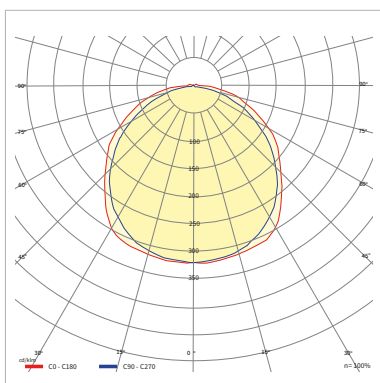

## Dostępne konfiguracje

| Rodzina                    | Wersja mocowa | Wersja    | Moc [W] | CRI      | Typ diody      | CCT [K] | Materiał soczewki  | Materiał dyfuzora       | Rozsył              | Sterowanie   | Temperatury pracy [°C] | Gwarancja    | Modyfikacje      |
|----------------------------|---------------|-----------|---------|----------|----------------|---------|--------------------|-------------------------|---------------------|--------------|------------------------|--------------|------------------|
| IND6ST<br>Industrial LED 6 | 1             | 8<br>ENEC | 032     | 8<br>>80 | A<br>Mid Power | 3000    | 0<br>Nie występuje | P21<br>PC transparentne | 110110<br>110°x110° | 00<br>ON/OFF | 3050<br>-30÷50         | 05Y<br>5 lat | 0000<br>Standard |
|                            | 1             |           | 32W     |          |                | 3000K   |                    |                         |                     |              |                        |              |                  |
|                            | 2             |           | 042     |          |                | 4000    |                    |                         |                     |              |                        |              |                  |
|                            | 2             |           | 42W     |          |                | 4000K   |                    |                         |                     |              |                        |              |                  |
| 3                          | 066           | 5000      |         |          |                |         |                    |                         |                     |              |                        |              |                  |
| 3                          | 66W           | 5000K     |         |          |                |         |                    |                         |                     |              |                        |              |                  |
| 4                          | 097           |           |         |          |                |         |                    |                         |                     |              |                        |              |                  |
| 4                          | 97W           |           |         |          |                |         |                    |                         |                     |              |                        |              |                  |

Przykładowy kod produktu:

[IND6ST.28.042.8A4000.OP21.110110.D0.2540.05Y.0000](#)