



# INDUSTRIAL BASIC LED 2.0



## Vorteile

- Hohe Lichtausbeute bis 163 lm / W.
- Gehäuse aus hochwertigem Polycarbonat
- Leuchte mit Schutzart IP66
- IK08 Widerstandsklasse
- 3 und 5 Jahre Garantieversionen verfügbar



### Industrial LED Basic 2.0 1

BAS2ST.10.030.8A4000	30	4350	4000K	>80	IP 66	110°x105°	2,0kg

### Industrial:LED Basic 2.0 2

BAS2ST.20.040.8A4000	40	5750	4000K	>80	IP 66	110°x105°	2,0kg









### Industrial:LED Basic 2.0 3

BAS2ST.30.046.8A4000	46	6550	4000K	>80	IP 66	110°x105°	2,0kg









### Industrial:LED Basic 2.0 4

BAS2ST.40.044.8A4000	44	7000	4000K	>80	IP 66	110°x105°	2,4kg

### Industrial:LED Basic 2.0 5

							
BAS2ST.50.048.8A4000	48	7850	4000K	>80	IP 66	110°x105°	2,4kg

### Industrial:LED Basic 2.0 6





							
BAS2ST.60.082.8A4000	82	11800	4000K	>80	IP 66	110°x105°	2,4kg

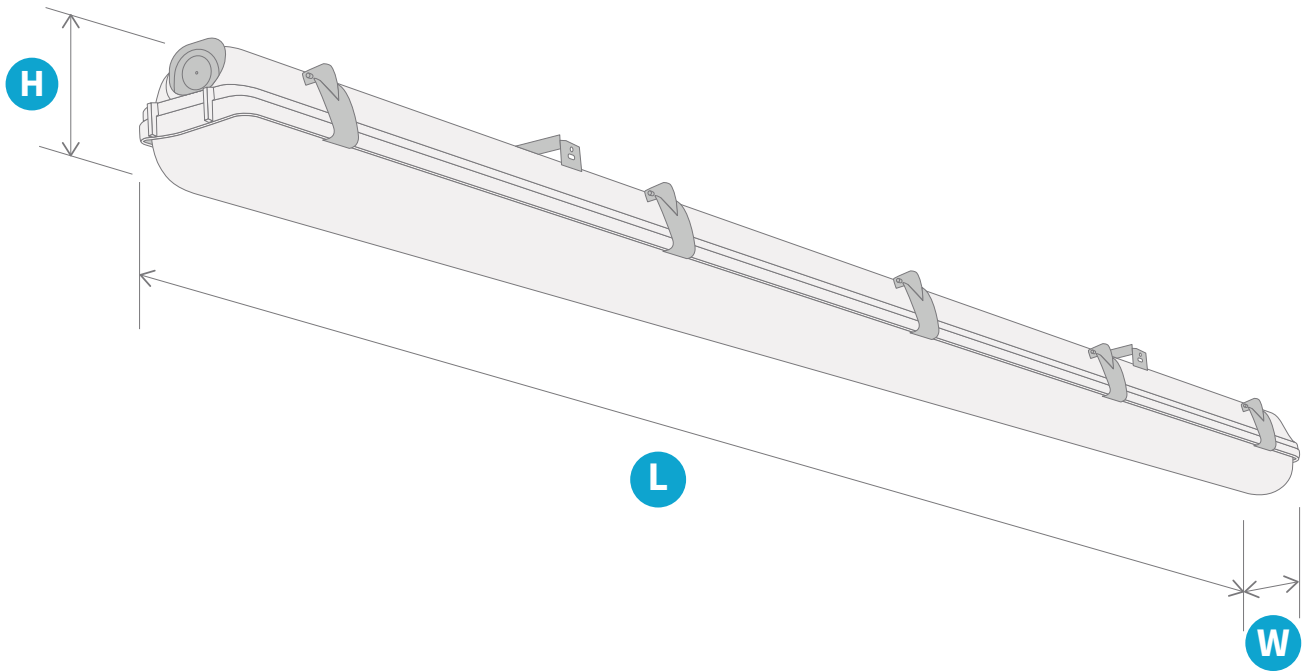

# Abmessungen und Logistik



	H	L	W
BAS2ST.1	80	1277	97
BAS2ST.2	80	1277	97
BAS2ST.3	80	1277	97
BAS2ST.4	80	1573	97
BAS2ST.5	80	1573	97
BAS2ST.6	80	1573	97

			
BAS2ST.1	10	100	130x80
BAS2ST.2	10	100	130x80
BAS2ST.3	10	100	130x80
BAS2ST.4	10	100	160x80
BAS2ST.5	10	100	160x80
BAS2ST.6	10	100	160x80

## Montageart

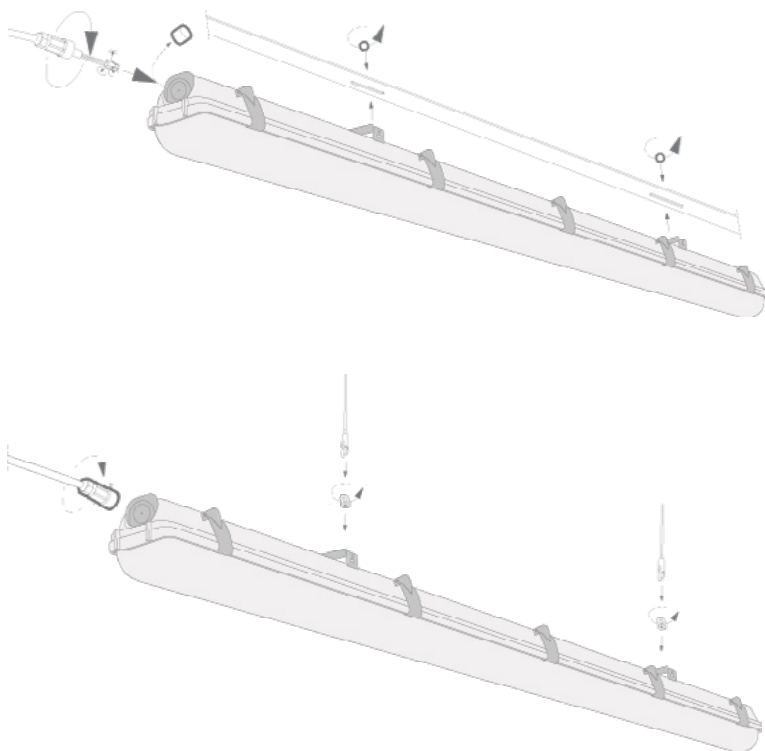

**Deckenaufbau**

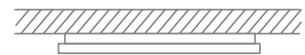

**Seilabhängung**



# Lichtstärke

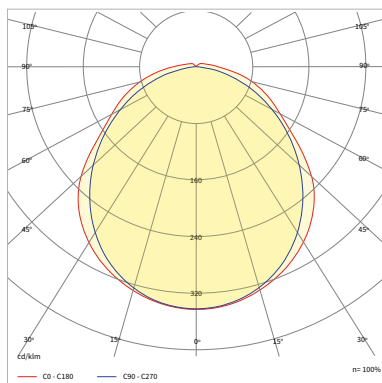

# Verfügbare Konfigurationen

Familie	Leistungs- version	Version	Nennleistung [W]	CRI	Typ der Diode	CCT [K]	Material der Linse	Material des Diffusors	Abstrahl- winkel	Lichtsteu- erung	Betriebstem- peratur [°C]	Garantie	Modifika- tionen	
BAS2ST INDUSTRIAL BASIC LED 2.0	1	0 Standard	030	8 >80	A Mid Power	4000	0 Keine Linse	P21 PC transpa- rent	110105 110° x 105°	00 ON/OFF	1540 -15÷40	03Y 3 Jahre	E001 Durch- gangsversion	
	1		30W			4000K				D0 DALI		05Y 5 Jahre	E010 Schnellan- schluss	
	2		040											
	2		40W											
	3		044											
	3		44W											
4	046													
4	46W													
5	048													
5	48W													
6	082													
6	82W												F004 Outdoor version	

Beispiel-Produktcode:

[BAS2ST.30.046.8A4000.OP21.110105.00.1540.03Y.F004](#)