

INDUSTRIAL GRP LED ST 6.0

Advantages

- High luminous efficiency up to 180Lm/W
- High protection class IP66
- Quick and easy installation
- Branded components
- Warranty up to 10 years
- High operating temperature range



*PMMA diffuser

Industrial GRP LED 6.0 1

	P	lm	K	Ra	IP		
ING6ST.10.017.8A3000	17	2900 - 2950	3000K	>80	IP 66	120°X110°	2kg
ING6ST.10.017.8A4000	17	3000 - 3050	4000K	>80	IP 66	120°X110°	2kg
ING6ST.10.017.8A5000	17	3050 - 3100	5000K	>80	IP 66	120°X110°	2kg
ING6ST.10.026.8A3000	26	4350 - 4450	3000K	>80	IP 66	120°X110°	2kg
ING6ST.10.026.8A4000	26	4500 - 4600	4000K	>80	IP 66	120°X110°	2kg
ING6ST.10.026.8A5000	26	4550 - 4650	5000K	>80	IP 66	120°X110°	2kg
ING6ST.10.032.8A3000	32	5450 - 5550	3000K	>80	IP 66	120°X110°	2kg
ING6ST.10.032.8A4000	32	5650 - 5750	4000K	>80	IP 66	120°X110°	2kg
ING6ST.10.032.8A5000	32	5700 - 5800	5000K	>80	IP 66	120°X110°	2kg









Industrial GRP LED 6.0 2

	P	lm	K	Ra	IP		
ING6ST.20.042.8A3000	42	7200 - 7350	3000K	>80	IP 66	120°X110°	2kg
ING6ST.20.042.8A4000	42	7450 - 7600	4000K	>80	IP 66	120°X110°	2kg
ING6ST.20.042.8A5000	42	7500 - 7650	5000K	>80	IP 66	120°X110°	2kg

Industrial GRP LED 6.0 3

	P	lm	K	Ra	IP		
ING6ST.30.066.8A3000	66	11500 - 11750	3000K	>80	IP 66	120°X110°	2,4kg
ING6ST.30.066.8A4000	66	11850 - 12100	4000K	>80	IP 66	120°X110°	2,4kg
ING6ST.30.066.8A5000	66	11900 - 12150	5000K	>80	IP 66	120°X110°	2,4kg



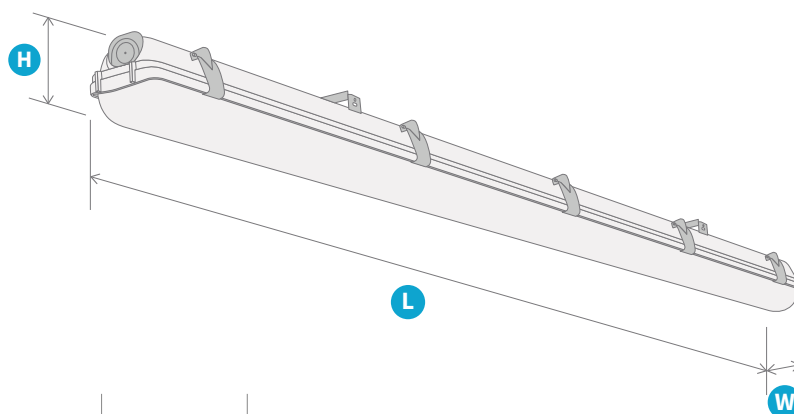

Industrial GRP LED 6.0 4

							
ING6ST.40.080.8A3000	80	12900 - 13150	3000K	>80	IP 66	120°X110°	2,4kg
ING6ST.40.080.8A4000	80	13300 - 13550	4000K	>80	IP 66	120°X110°	2,4kg
ING6ST.40.080.8A5000	80	13350 - 13600	5000K	>80	IP 66	120°X110°	2,4kg
ING6ST.40.097.8A3000	97	15300 - 15600	3000K	>80	IP 66	120°X110°	2,4kg
ING6ST.40.097.8A4000	97	15800 - 16100	4000K	>80	IP 66	120°X110°	2,4kg
ING6ST.40.097.8A5000	97	15850 - 16150	5000K	>80	IP 66	120°X110°	2,4kg

Dimensions and Logistics



	H	L	W
ING6ST.1	84	1277	97
ING6ST.2	84	1277	97
ING6ST.3	84	1573	97
ING6ST4	84	1573	97

			
ING6ST	10	100	160x80

Montage

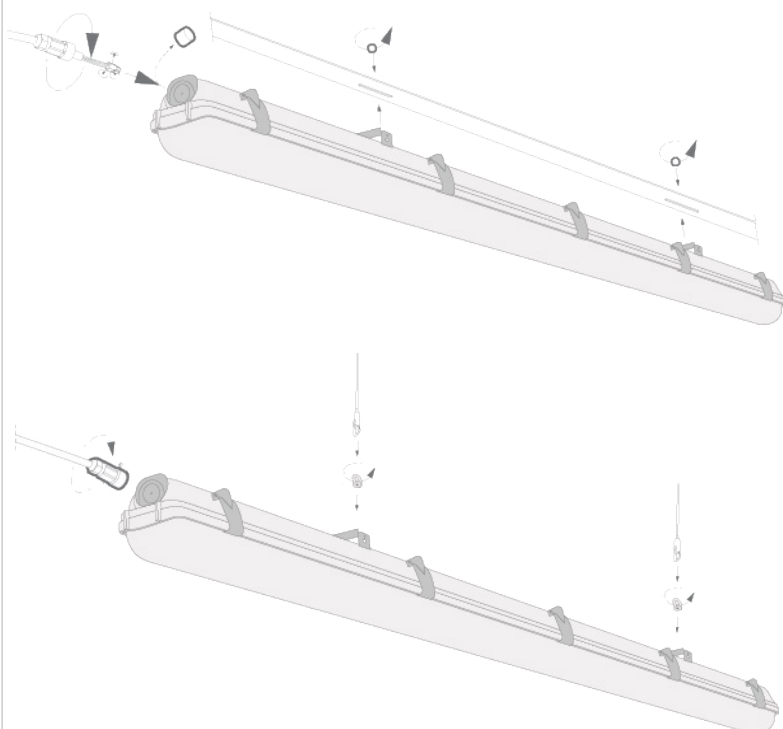

surface mounting



suspended

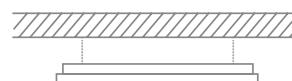

Luminous Intensity Distribution

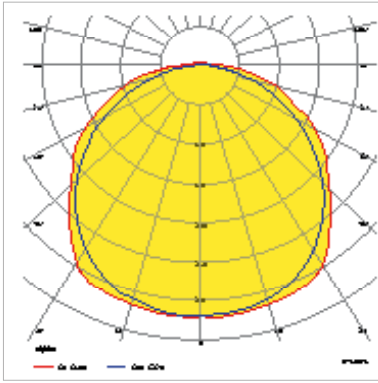

Available Configurations

Family	Power version	Certificate	Power [W]	CRI	Diode type	CCT [K]	Lens material	Diffuser material	Beam angle	Type of control	Operating temperature[°C]	Warranty	Modifications
ING6ST Industrial GRP LED 6.0	1	0 Standard	017	8 >80	A Mid Power	3000	0 No lens	P11 PC Transparent	120110 120°x110°	00 ON/OFF	0030 0÷30	05Y 5 years	0000 Standard
	2		026			4000		P21 PMMA Transparent		D0 DALI	2540 -25÷40	08Y 8 years	E001 Through-wired
	3		032			5000		E3 Emergency module 3h		3550 -25÷50	10Y 10 years	E004 Through-wired; Quick connector	
	4		042								E010 Quick connector		
			066										
			080										
			097										

Example product code:

[ING6ST.20.042.8A3000.OP11.120110.D0.2540.10Y.E001](#)