



MADRID LED A 1.0

Vorteile

- Leuchte mit IP66-Schutzklasse
- Markenkomponenten
- Hohe Schlagfestigkeit IK09
- Solides Aluminiumgehäuse



Madrid LED A 1.0 1





MAD1WA.10.025.8A3000	25	2750	3000K	>80	IP 66	135°x135°	7,1 kg

Madrid LED A 1.0 2

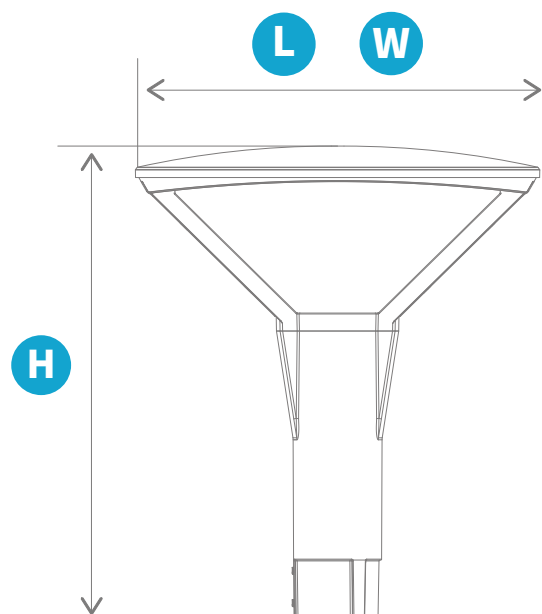
MAD1WA.20.050.8A3000	50	5700	3000K	>80	IP 66	135°x135°	7,1 kg

Abmessungen und Logistik



	H	L	W
MAD1WA	526	450	450
			
MAD1WA	1	24	120x80

Montageart



Pfostenmontage



Lichtstärke

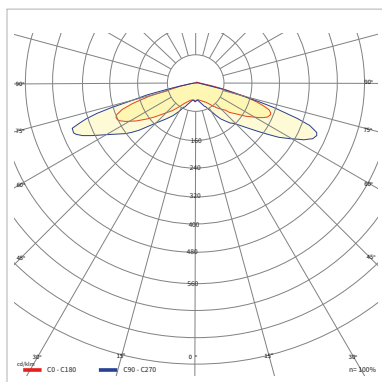

Verfügbare Konfigurationen

Familie	Leistungs- version	Version	Nennleistung [W]	CRI	Typ der Diode	CCT [K]	Material der Linse	Material des Diffusors	Abstrahl- winkel	Lichtsteu- erung	Betriebstem- peratur [°C]	Garantie	Modifika- tionen
MAD1WA MADRID LED A 1.0	1	0	025	8	A	3000	1	G11	135135	B0	3045	05Y	0000
	1	Standard	25W	>80	Mid Power	3000K	PMMA	Gehärtetes Glas Transparent	135°x135°	Time dimming	-30+45	5 Jahre	Standard
	2		050										
	2		50W										

Beispiel-Produktcode:

[MAD1WA.10.025.8A3000.1G11.135135.B0.3045.05Y.0000](#)