



SQFlat LED 1.0



Przewagi

- Szybki i prosty montaż
- Niski współczynnik UGR
- Szeroki wachlarz dostępnych mocy
- Dostępne wersje ze sterowaniem DALI



SQFlat LED 1.0 1

SQF1ST.10.019.8A4000	19	2550	4000K	>80	20	90°	2,1kg

SQFlat LED 1.0 2

SQF1ST.20.023.8A4000	23	3100	4000K	>80	20	90°	2,1kg

SQFlat LED 1.0 3

SQF1ST.30.027.8A4000	27	3600	4000K	>80	20	90°	2,1kg







SQFlat LED 1.0 4

SQF1ST.40.032.8A4000	32	4200	4000K	>80	20	90°	2,1kg









SQFlat LED 1.0 5

SQF1ST.50.036.8A4000	36	4650	4000K	>80	20	90°	2,1kg

SQFlat LED 1.0 6

							
SQF1ST.60.042.8A4000	42	5350	4000K	>80	20	90°	2,1kg

SQFlat LED 1.0 7

							
SQF1ST.70.048.8A4000	48	5950	4000K	>80	20	90°	2,1kg

Wymiarowanie i Logistyka

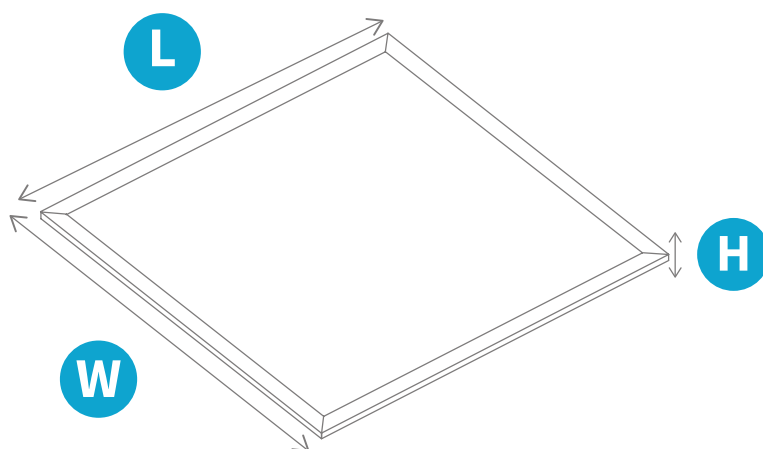

	H	L	W
SQF1ST	10	595	595

Montaż



montaż podtynkowy



montaż natynkowy



montaż zwieszany

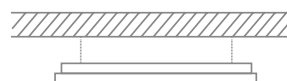

sufit G-K



Rozsył Światłości

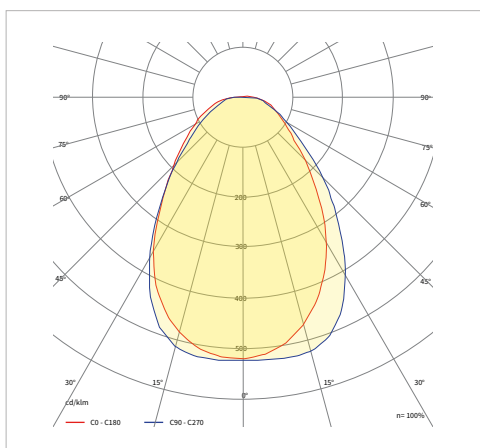

Dostępne konfiguracje

Rodzina	Wersja mocowa	Wersja	Moc [W]	CRI	Typ diody	CCT [K]	Materiał soczewki	Materiał dyfuzora	Rozsył	Sterowanie	Temperatury pracy [°C]	Gwarancja	Modyfikacje
SQF1ST SQFLAT LED 1.0	1	0	019	8	A	4000	0	P34	090090	00	2040	05Y	0000
	1	Standard	19W	>80	Mid Power	4000K	Nie występuje	Dyfuzor PS mikropryzmatyczny	90° x90°	ON/OFF	-20+40	5 lat	Standard
	2		023							D0			
	2		23W							Dali Przewodowe			
	3		027										
	3		27W										
	4		032										
	4		32W										
5		036											
5		36W											
6		042											
6		42W											
7		048											
7		48W											

Przykładowy kod produktu:

[SQF1ST.20.023.8A4000.OP34.090090.00.2040.05Y.0000](#)