



SQLIGHT LED 1.0



Vorteile

- Garantie 5 Jahren
- Diffusor zur Begrenzung des Blendungsfaktors
- Perfekte Gleichmäßigkeit der Beleuchtung
- Markenkomponenten



SQLight LED 1.0 1

SQL1ST.11.019	19	2700	4000	> 80	40	90°	1,5kg

SQLight LED 1.0 2

SQL1ST.21.023	23	3250	4000	> 80	40	90°	1,5kg

SQLight LED 1.0 3

SQL1ST.t31.027	27	3800	4000	> 80	40	90°	1,5kg









SQLight LED 1.0 4

SQL1ST.41.030	30	4150	4000	> 80	40	90°	1,5kg

SQLight LED 1.0 5

SQL1ST.51.034	34	4650	4000	> 80	40	90°	1,5kg

SQLight LED 1.0 6

							
SQL1ST.61.040	40	5400	4000	> 80	40	90°	1,5kg

Abmessungen und Logistik

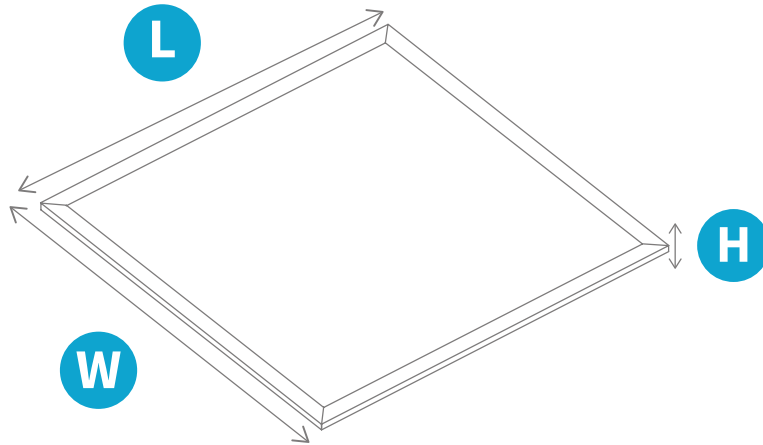

							
SQL1ST	35	595	595	SQL1ST	6	48	120x80

Montageart



Deckeneinbau

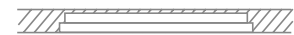

Deckenaufbau

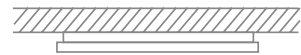

Gipskarton



Seilabhängung

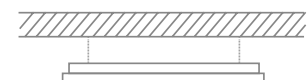

Lichtstärke

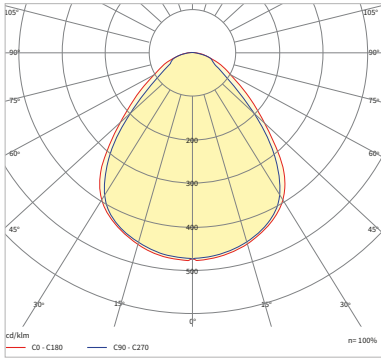

Verfügbare Konfigurationen

Familie	Leistungs- version	Version	Nennleistung [W]	CRI	Typ der Diode	CCT [K]	Material der Linse	Material des Diffusors	Abstrahl- winkel	Lichtsteu- erung	Betriebstem- peratur [°C]	Garantie	Modifika- tionen
SQL1ST SQLight LED 1.0	1	1	019	8	A	4000	1	P34	090090	00	1040	05Y	0000
	1	Lift	19W	>80	Mid Power	4000K	PMMA	PS mikropri- smatisch	90°x90°	ON/OFF	-10°C ÷ 40°C	5 Jahre	Standard
	2		023							D0			
	2		23W							DALI			
	3		027										
	3		27W										
4		030											
4		30W											
5		034											
5		34W											
6		040											
6		40W											

Beispiel-Produktcode:

SQL1ST.21.023.8A4000.1P34.090090.D0.0040.05Y.0000

Verfügbares Zubehör

	<p>Deckeneinbau - BCK-60-RAMA-SF-T</p>
	<p>Gipskarton - ED-60-RAMA-PS-C</p>