



SKYLIGHT LED 4.0



Vorteile

- Die Leuchte ist zur Beleuchtung der Außenbereiche von Industrie- und Logistikobjekten bestimmt
- Hochwertige Komponenten: Diffusor aus Hartglas, Gehäuse aus Aluminium
- Markenlinsen beleuchten die meisten Oberfläche präzise
- Einstellbarer Beleuchtungswinkel



Skylight LED 4.0 1

SKL4ST.10.022.8A3000	22	2900 - 3500	3000K	>80	IP65	30°, 60°, 90°, 110°, 145°X35° 145°X65°, 155°X35°	2,5kg
SKL4ST.10.022.8A4000	22	3050 - 3650	4000K	>80	IP65	30°, 60°, 90°, 110°, 145°X35° 145°X65°, 155°X35°	2,5kg
SKL4ST.10.022.8A5000	22	3100 - 3700	5000K	>80	IP65	30°, 60°, 90°, 110°, 145°X35° 145°X65°, 155°X35°	2,5kg

Skylight LED 4.0 2









SKL4ST.20.039.8A3000	39	4750 - 5700	3000K	>80	IP65	30°, 60°, 90°, 110°, 145°X35° 145°X65°, 155°X35°	2,5kg
SKL4ST.20.039.8A4000	39	5000 - 6000	4000K	>80	IP65	30°, 60°, 90°, 110°, 145°X35° 145°X65°, 155°X35°	2,5kg
SKL4ST.20.039.8A5000	39	5050 - 6050	5000K	>80	IP65	30°, 60°, 90°, 110°, 145°X35° 145°X65°, 155°X35°	2,5kg

Skylight LED 4.0 3

SKL4ST.30.071.8A3000	71	9850 - 11350	3000K	>80	IP65	30°, 60°, 90°, 110°, 145°X35° 145°X65°, 155°X35°	5,7kg
SKL4ST.30.071.8A4000	71	10300 - 11400	4000K	>80	IP65	30°, 60°, 90°, 110°, 145°X35° 145°X65°, 155°X35°	5,7kg
SKL4ST.30.071.8A5000	71	10350 - 11400	5000K	>80	IP65	30°, 60°, 90°, 110°, 145°X35° 145°X65°, 155°X35°	5,7kg

Um die Lichtparameter für den ausgewählten Abstrahlwinkel genau zu kennen, verwenden Sie bitte photometrische Dateien für den angegebenen Abstrahlwinkel. Download-Link: luxon.pl/Pliki/LDT-LUXON-LED-2020.zip









Skylight LED 4.0 4

							
SKL4ST.40.112.8A3000	112	15550 - 17900	3000K	>80	IP65	30°, 60°, 90°, 110°, 145°X35° 145°X65°, 155°X35°	5,7kg
SKL4ST.40.112.8A4000	112	16300 - 17950	4000K	>80	IP65	30°, 60°, 90°, 110°, 145°X35° 145°X65°, 155°X35°	5,7kg
SKL4ST.40.112.8A5000	112	16350 - 17950	5000K	>80	IP65	30°, 60°, 90°, 110°, 145°X35° 145°X65°, 155°X35°	5,7kg







Skylight LED 4.0 5

							
SKL4ST.50.157.8A3000	157	21350 - 24500	3000K	>80	IP65	30°, 60°, 90°, 110°, 145°X35° 145°X65°, 155°X35°	5,7kg
SKL4ST.50.157.8A4000	157	22300 - 24550	4000K	>80	IP65	30°, 60°, 90°, 110°, 145°X35° 145°X65°, 155°X35°	5,7kg
SKL4ST.50.157.8A5000	157	22350 - 24550	5000K	>80	IP65	30°, 60°, 90°, 110°, 145°X35° 145°X65°, 155°X35°	5,7kg









Skylight LED 4.0 6

							
SKL4ST.60.193.8A3000	193	25500 - 28000	3000K	>80	IP65	30°, 60°, 90°, 110°, 145°X35° 145°X65°, 155°X35°	6kg
SKL4ST.60.193.8A4000	193	26600 - 29200	4000K	>80	IP65	30°, 60°, 90°, 110°, 145°X35° 145°X65°, 155°X35°	6kg
SKL4ST.60.193.8A5000	193	26650 - 29250	5000K	>80	IP65	30°, 60°, 90°, 110°, 145°X35° 145°X65°, 155°X35°	6kg

Skylight LED 4.0 7

							
SKL4ST.70.219.8A3000	219	29650 - 33100	3000K	>80	IP65	30°, 60°, 90°, 110°, 145°X35° 145°X65°, 155°X35°	8,7kg
SKL4ST.70.219.8A4000	219	31200 - 34800	4000K	>80	IP65	30°, 60°, 90°, 110°, 145°X35° 145°X65°, 155°X35°	8,7kg
SKL4ST.70.219.8A5000	219	31250 - 34950	5000K	>80	IP65	30°, 60°, 90°, 110°, 145°X35° 145°X65°, 155°X35°	8,7kg

Skylight LED 4.0 8

							
SKL4ST.80.278.8A3000	278	37900 - 42300	3000K	>80	IP65	30°, 60°, 90°, 110°, 145°X35° 145°X65°, 155°X35°	8,7kg
SKL4ST.80.278.8A4000	278	39900 - 44500	4000K	>80	IP65	30°, 60°, 90°, 110°, 145°X35° 145°X65°, 155°X35°	8,7kg
SKL4ST.80.278.8A5000	278	39950 - 44650	5000K	>80	IP65	30°, 60°, 90°, 110°, 145°X35° 145°X65°, 155°X35°	8,7kg

Montageart





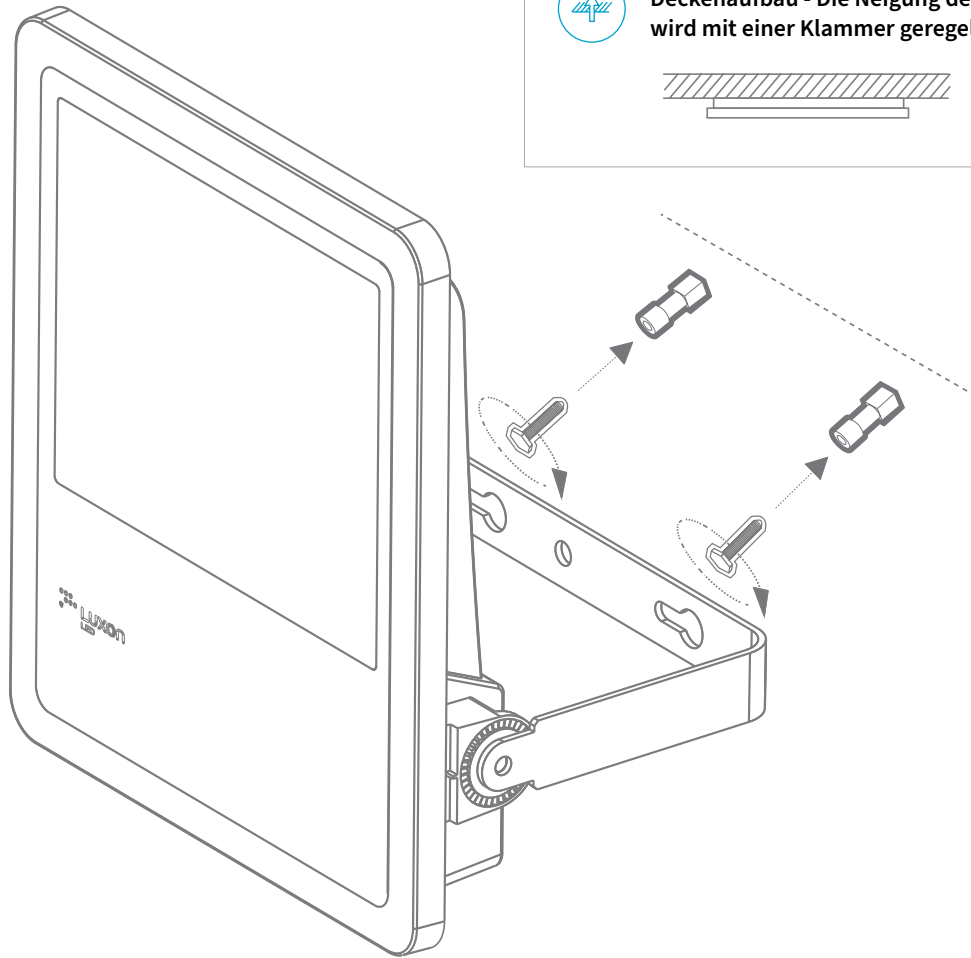
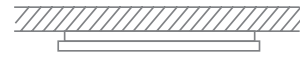

Deckenaufbau - Die Neigung der Leuchte wird mit einer Klammer geregelt

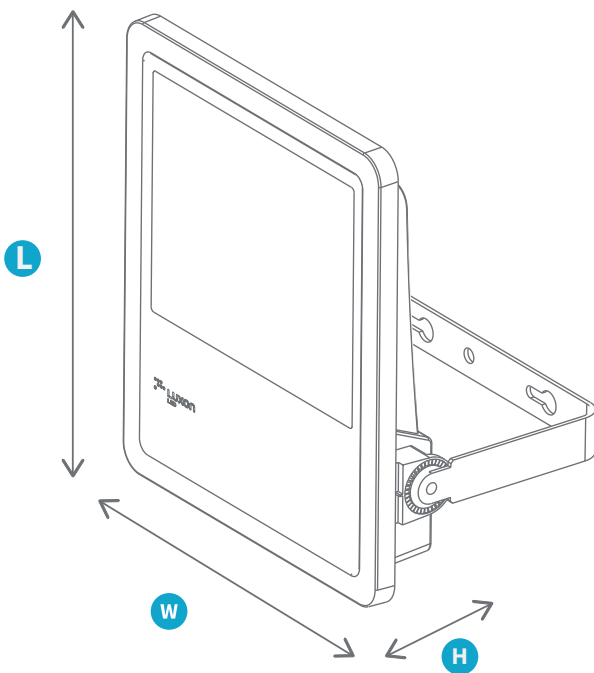

Abmessungen und Logistik



	H	L	W
SKL4ST.1	67	280	275
SKL4ST.2	67	280	275
SKL4ST.3	78	422	400
SKL4ST.4	78	422	400
SKL4ST.5	78	422	400
SKL4ST.6	78	422	400
SKL4ST.7	60	582	444
SKL4ST.8	60	582	444

			
SKL4ST.1	3	30	120x80
SKL4ST.2	3	30	120x80
SKL4ST.3	3	30	120x80
SKL4ST.4	3	30	120x80
SKL4ST.5	3	30	120x80
SKL4ST.6	3	30	120x80
SKL4ST.7	2	30	120x80

Lichtstärke

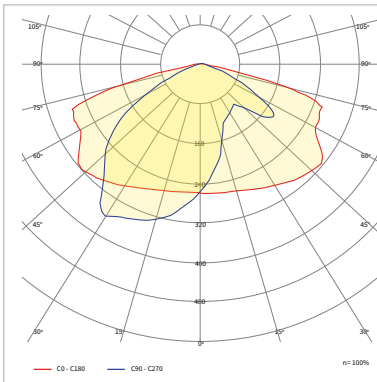
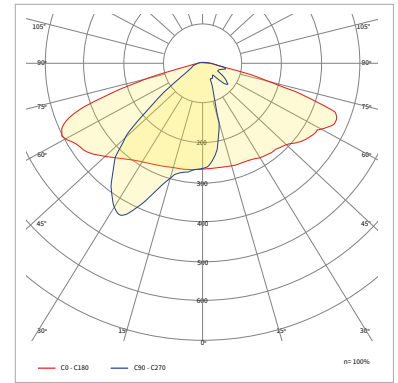
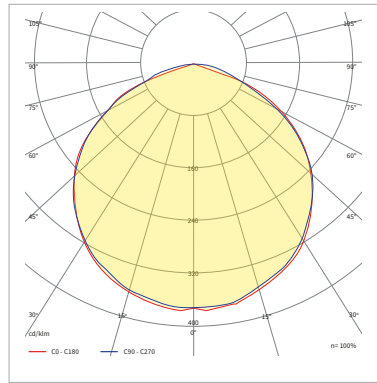
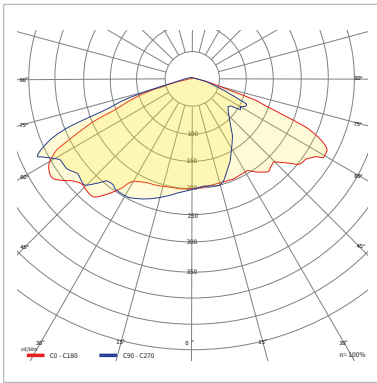
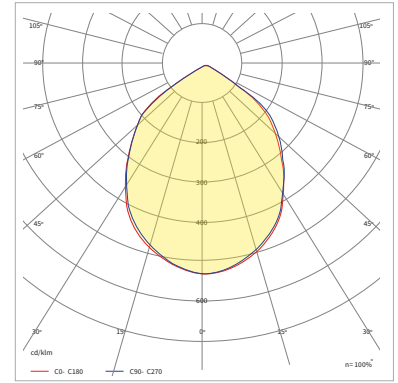
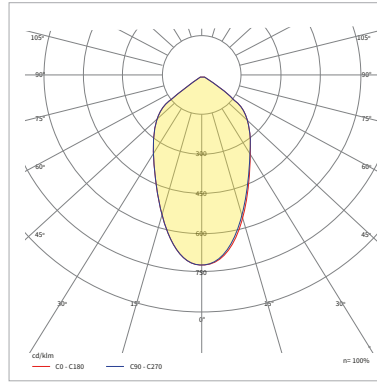
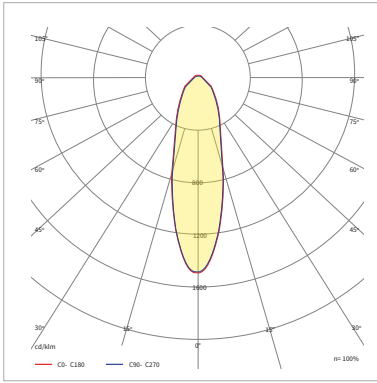

Verfügbare Konfigurationen

Familie	Leistungs- version	Version	Nennleistung [W]	CRI	Typ der Diode	CCT [K]	Material der Linse	Material des Diffusors	Abstrahl- winkel	Lichtsteu- erung	Betriebstem- peratur [°C]	Garantie	Modifika- tionen
SKL4ST Skylight LED 4.0	1	0	022	8	A	3000	0	G11 Gehärtetes Glas transparent	030030	00	3540	05Y	0000
	1	Standard	22W	>80	Mid Power	3000K	Keine Linse		30°x30°	ON/OFF	-35+40	5 Jahre	Standard
	2		039			4000	1		060060	D0	3545	08Y	
	2		39W			4000K	PMMA		60°x60°	DALI	-35+45	8 Jahre	
	3		071			5000			090090		2040		
	3		71W			5000K			90°x90°		-20+40		
	4		112						110110				
	4		112W						110°x110°				
5		157					145035						
5		157W					145°x35°						
6		193					145065						
6		193W					145°x65°						
7		219					155035						
7		219W					155°x35°						
8		278											
8		278W											

Beispiel-Produktcode

SKL4ST.20.039.8A5000.1G11.030030.00.2040.05Y.0000