



TRACKLIGHT LED 3.1

Advantages









- Ability to direct the light beam as desired
- Quick and easy installation
- Branded components
- Solid aluminum housing
- High CRI>90











Tracklight LED 3.1 1

TRC3ST.11.013.8D2700	13	1700	2700K	>80	IP 20	15°, 20°, 35°, 50°, 65°	0,7kg
TRC3ST.11.013.8D3000	13	1700	3000K	>80	IP 20	15°, 20°, 35°, 50°, 65°	0,7kg
TRC3ST.11.013.8D4000	13	1750	4000K	>80	IP 20	15°, 20°, 35°, 50°, 65°	0,7kg
TRC3ST.11.013.8D5000	13	1750	5000K	>80	IP 20	15°, 20°, 35°, 50°, 65°	0,7kg
TRC3ST.11.013.8E2000	13	1100	2000K	>80	IP 20	15°, 20°, 35°, 50°, 65°	0,7kg
TRC3ST.11.013.8E2500	13	1500	2500K	>80	IP 20	15°, 20°, 35°, 50°, 65°	0,7kg
TRC3ST.11.013.9D2700	13	1500	2700K	>90	IP 20	15°, 20°, 35°, 50°, 65°	0,7kg
TRC3ST.11.013.9D3000	13	1500	3000K	>90	IP 20	15°, 20°, 35°, 50°, 65°	0,7kg
TRC3ST.11.013.9D4000	13	1550	4000K	>90	IP 20	15°, 20°, 35°, 50°, 65°	0,7kg
TRC3ST.11.013.9E3000	13	1400	3000K	>90	IP 20	15°, 20°, 35°, 50°, 65°	0,7kg
TRC3ST.11.013.9E4200	13	1250	4200K	>90	IP 20	15°, 20°, 35°, 50°, 65°	0,7kg
TRC3ST.11.013.9E5700	13	1600	5700K	>90	IP 20	15°, 20°, 35°, 50°, 65°	0,7kg
TRC3ST.11.013.9F3000	13	1400	3000K	>90	IP 20	15°, 20°, 35°, 50°, 65°	0,7kg
TRC3ST.11.013.9G3000	13	1600	3000K	>90	IP 20	15°, 20°, 35°, 50°, 65°	0,7kg
TRC3ST.11.013.9G3500	13	1650	3500K	>90	IP 20	15°, 20°, 35°, 50°, 65°	0,7kg
TRC3ST.11.013.9G4000	13	1700	4000K	>90	IP 20	15°, 20°, 35°, 50°, 65°	0,7kg







Tracklight LED 3.1 2

							
TRC3ST.21.019.8D2700	19	2400	2700K	>80	IP 20	15°, 20°, 35°, 50°, 65°	0,7kg
TRC3ST.21.019.8D3000	19	2400	3000K	>80	IP 20	15°, 20°, 35°, 50°, 65°	0,7kg
TRC3ST.21.019.8D4000	19	2500	4000K	>80	IP 20	15°, 20°, 35°, 50°, 65°	0,7kg
TRC3ST.21.019.8D5000	19	2500	5000K	>80	IP 20	15°, 20°, 35°, 50°, 65°	0,7kg
TRC3ST.21.019.8E2000	19	1550	2000K	>80	IP 20	15°, 20°, 35°, 50°, 65°	0,7kg
TRC3ST.21.019.8E2500	19	2100	2500K	>80	IP 20	15°, 20°, 35°, 50°, 65°	0,7kg
TRC3ST.21.019.9D2700	19	2150	2700K	>90	IP 20	15°, 20°, 35°, 50°, 65°	0,7kg
TRC3ST.21.019.9D3000	19	2150	3000K	>90	IP 20	15°, 20°, 35°, 50°, 65°	0,7kg
TRC3ST.21.019.9D4000	19	2250	4000K	>90	IP 20	15°, 20°, 35°, 50°, 65°	0,7kg
TRC3ST.21.019.9E3000	19	1950	3000K	>90	IP 20	15°, 20°, 35°, 50°, 65°	0,7kg
TRC3ST.21.019.9E4200	19	1750	4200K	>90	IP 20	15°, 20°, 35°, 50°, 65°	0,7kg
TRC3ST.21.019.9E5700	19	2250	5700K	>90	IP 20	15°, 20°, 35°, 50°, 65°	0,7kg
TRC3ST.21.019.9F3000	19	2000	3000K	>90	IP 20	15°, 20°, 35°, 50°, 65°	0,7kg
TRC3ST.21.019.9G3000	19	2250	3000K	>90	IP 20	15°, 20°, 35°, 50°, 65°	0,7kg
TRC3ST.21.019.9G3500	19	2300	3500K	>90	IP 20	15°, 20°, 35°, 50°, 65°	0,7kg
TRC3ST.21.019.9G4000	19	2400	4000K	>90	IP 20	15°, 20°, 35°, 50°, 65°	0,7kg

Tracklight LED 3.1 3

							
TRC3ST.31.021.8D2700	21	1700	2700K	>80	IP 20	15°, 20°, 35°, 50°, 65°	0,7kg
TRC3ST.31.021.8D3000	21	1700	3000K	>80	IP 20	15°, 20°, 35°, 50°, 65°	0,7kg
TRC3ST.31.021.8D4000	21	1750	4000K	>80	IP 20	15°, 20°, 35°, 50°, 65°	0,7kg
TRC3ST.31.021.8D5000	21	1750	5000K	>80	IP 20	15°, 20°, 35°, 50°, 65°	0,7kg
TRC3ST.31.021.8E2000	21	1100	2000K	>80	IP 20	15°, 20°, 35°, 50°, 65°	0,7kg
TRC3ST.31.021.8E2500	21	1500	2500K	>80	IP 20	15°, 20°, 35°, 50°, 65°	0,7kg
TRC3ST.31.021.9D2700	21	1500	2700K	>90	IP 20	15°, 20°, 35°, 50°, 65°	0,7kg
TRC3ST.31.021.9D3000	21	1500	3000K	>90	IP 20	15°, 20°, 35°, 50°, 65°	0,7kg
TRC3ST.31.021.9D4000	21	1550	4000K	>90	IP 20	15°, 20°, 35°, 50°, 65°	0,7kg
TRC3ST.31.021.9E3000	21	1400	3000K	>90	IP 20	15°, 20°, 35°, 50°, 65°	0,7kg
TRC3ST.31.021.9E4200	21	1250	4200K	>90	IP 20	15°, 20°, 35°, 50°, 65°	0,7kg
TRC3ST.31.021.9E5700	21	1600	5700K	>90	IP 20	15°, 20°, 35°, 50°, 65°	0,7kg
TRC3ST.31.021.9F3000	21	1400	3000K	>90	IP 20	15°, 20°, 35°, 50°, 65°	0,7kg
TRC3ST.31.021.9G3000	21	1600	3000K	>90	IP 20	15°, 20°, 35°, 50°, 65°	0,7kg
TRC3ST.31.021.9G3500	21	1650	3500K	>90	IP 20	15°, 20°, 35°, 50°, 65°	0,7kg
TRC3ST.31.021.9G4000	21	1700	4000K	>90	IP 20	15°, 20°, 35°, 50°, 65°	0,7kg



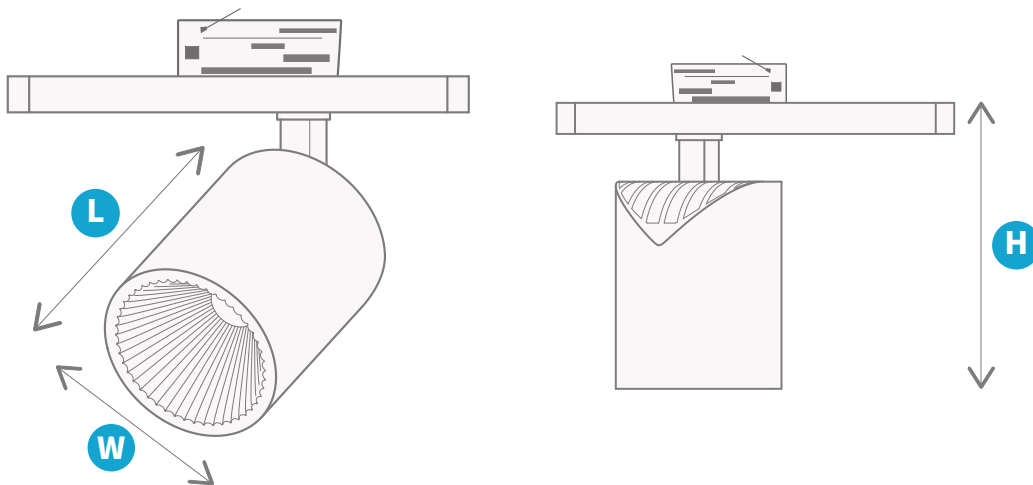

Tracklight LED 3.1 4

							
TRC3ST.41.023.8D2700	23	2900	2700K	>80	IP 20	15°, 20°, 35°, 50°, 65°	0,7kg
TRC3ST.41.023.8D3000	23	2900	3000K	>80	IP 20	15°, 20°, 35°, 50°, 65°	0,7kg
TRC3ST.41.023.8D4000	23	3000	4000K	>80	IP 20	15°, 20°, 35°, 50°, 65°	0,7kg
TRC3ST.41.023.8D5000	23	3000	5000K	>80	IP 20	15°, 20°, 35°, 50°, 65°	0,7kg
TRC3ST.41.023.8E2000	23	1800	2000K	>80	IP 20	15°, 20°, 35°, 50°, 65°	0,7kg
TRC3ST.41.023.8E2500	23	2500	2500K	>80	IP 20	15°, 20°, 35°, 50°, 65°	0,7kg
TRC3ST.41.023.9D2700	23	2600	2700K	>90	IP 20	15°, 20°, 35°, 50°, 65°	0,7kg
TRC3ST.41.023.9D3000	23	2600	3000K	>90	IP 20	15°, 20°, 35°, 50°, 65°	0,7kg
TRC3ST.41.023.9D4000	23	2700	4000K	>90	IP 20	15°, 20°, 35°, 50°, 65°	0,7kg
TRC3ST.41.023.9E3000	23	2300	3000K	>90	IP 20	15°, 20°, 35°, 50°, 65°	0,7kg
TRC3ST.41.023.9E4200	23	2100	4200K	>90	IP 20	15°, 20°, 35°, 50°, 65°	0,7kg
TRC3ST.41.023.9E5700	23	2700	5700K	>90	IP 20	15°, 20°, 35°, 50°, 65°	0,7kg
TRC3ST.41.023.9F3000	23	2050	3000K	>90	IP 20	15°, 20°, 35°, 50°, 65°	0,7kg
TRC3ST.41.023.9G3000	23	2350	3000K	>90	IP 20	15°, 20°, 35°, 50°, 65°	0,7kg
TRC3ST.41.023.9G3500	23	2400	3500K	>90	IP 20	15°, 20°, 35°, 50°, 65°	0,7kg
TRC3ST.41.023.9G4000	23	2550	4000K	>90	IP 20	15°, 20°, 35°, 50°, 65°	0,7kg

Dimensions and Logistics



	H	L	W
TRC3ST	143	96	Ø 84

			
TRC3ST	1	128	120x80

Montage

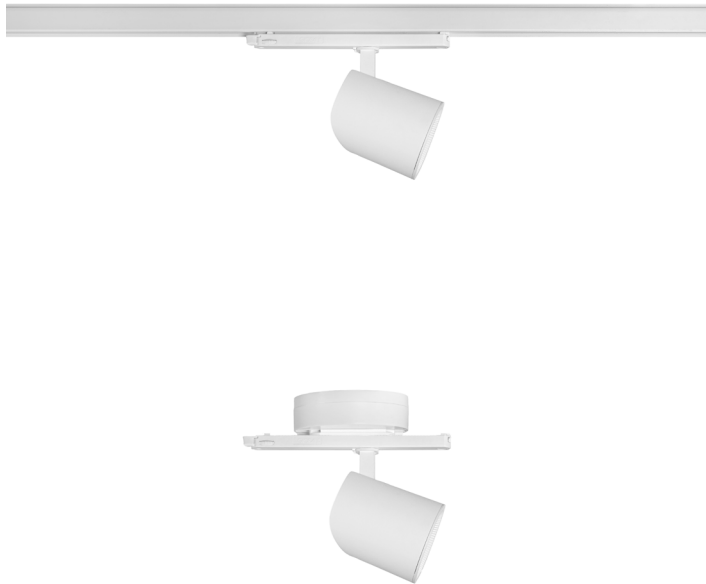

3-phase rail

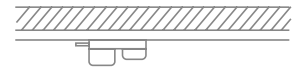

surface adapter

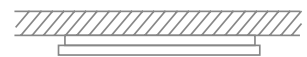

Luminous Intensity Distribution

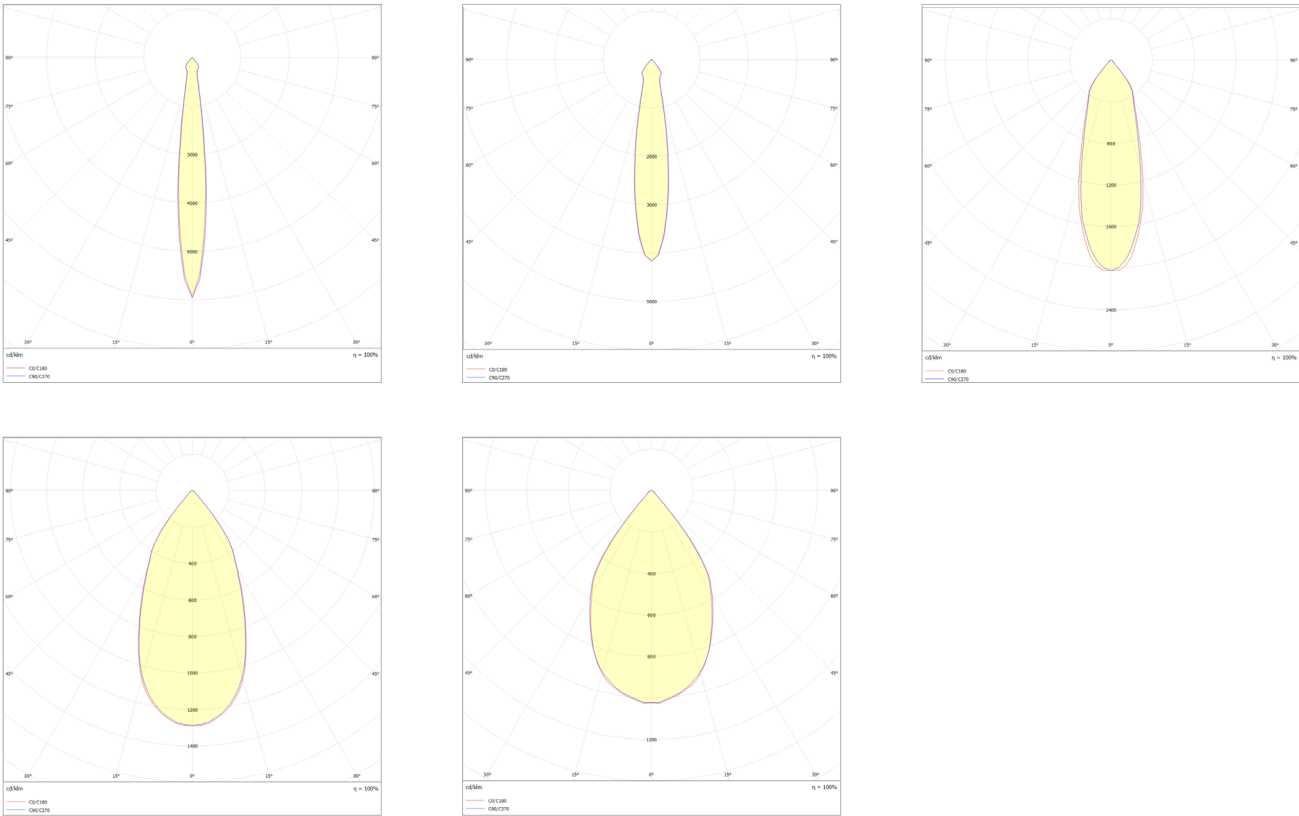

Available configurations

Family	Power version	Version	Power [W]	CRI	Diode type	CCT [K]	Lens material	Diffuser material	Beam angle	Type of control	Operating temperature[°C]	Warranty	Modifications	
TRC3ST Tracklight LED 3	1	1 Lift 1	013 13W	8 >80	D COB	2000 2000K	0 No lens	S35 ABS Reflector glossy	020020 20°x20°	00 ON/OFF	2035 -25 °C ÷ 35 °C	05Y 5 years	B001 Black, RAL9005	
			019 19W	9 >90	E COB Food/ special app.	2500 2500K			035035 35°x35°					W001 White, RAL9016
			021 21W	F COB Premium Color	2700 2700K	050050 50°x50°								
			023 23W		G COB Premium White	3000 3000K			065065 65°x65°					
				3500 3500K										
				4000 4000K										
				4200 4200K										
				5000 5000K										
				5700 5700K										

Example product code:

TRC3ST.11.013.8D2700.0S35.020020.00.2035.05Y.W001