



TRACKLIGHT LED 3.1

Przewagi

- Możliwość dowolnego skierowania wiązki światła
- Szybki i prosty montaż
- Markowe komponenty
- Solidna obudowa wykonana z aluminium
- Wysokie CRI>90











Tracklight LED 3.1 1









TRC3ST.11.013.8D2700	13	1700	2700K	>80	IP 20	15°, 20°, 35°, 50°, 65°	1,1kg
TRC3ST.11.013.8D3000	13	1700	3000K	>80	IP 20	15°, 20°, 35°, 50°, 65°	1,1kg
TRC3ST.11.013.8D4000	13	1750	4000K	>80	IP 20	15°, 20°, 35°, 50°, 65°	1,1kg
TRC3ST.11.013.8D5000	13	1750	5000K	>80	IP 20	15°, 20°, 35°, 50°, 65°	1,1kg
TRC3ST.11.013.8E2000	13	1100	2000K	>80	IP 20	15°, 20°, 35°, 50°, 65°	1,1kg
TRC3ST.11.013.8E2500	13	1500	2500K	>80	IP 20	15°, 20°, 35°, 50°, 65°	1,1kg
TRC3ST.11.013.9D2700	13	1500	2700K	>90	IP 20	15°, 20°, 35°, 50°, 65°	1,1kg
TRC3ST.11.013.9D3000	13	1500	3000K	>90	IP 20	15°, 20°, 35°, 50°, 65°	1,1kg
TRC3ST.11.013.9D4000	13	1550	4000K	>90	IP 20	15°, 20°, 35°, 50°, 65°	1,1kg
TRC3ST.11.013.9E3000	13	1400	3000K	>90	IP 20	15°, 20°, 35°, 50°, 65°	1,1kg
TRC3ST.11.013.9E4200	13	1250	4200K	>90	IP 20	15°, 20°, 35°, 50°, 65°	1,1kg
TRC3ST.11.013.9E5700	13	1600	5700K	>90	IP 20	15°, 20°, 35°, 50°, 65°	1,1kg
TRC3ST.11.013.9F3000	13	1400	3000K	>90	IP 20	15°, 20°, 35°, 50°, 65°	1,1kg
TRC3ST.11.013.9G3000	13	1600	3000K	>90	IP 20	15°, 20°, 35°, 50°, 65°	1,1kg
TRC3ST.11.013.9G3500	13	1650	3500K	>90	IP 20	15°, 20°, 35°, 50°, 65°	1,1kg
TRC3ST.11.013.9G4000	13	1700	4000K	>90	IP 20	15°, 20°, 35°, 50°, 65°	1,1kg

W celu zapoznania się z parametrami świetlnymi, dla danego kąta rozsyłu światłości prosimy o posługiwanie się plikami fotometrycznymi. Link do pobrania: luxon.pl/Pliki/LDT-LUXON-LED-2020.zip









Tracklight LED 3.1 2

							
TRC3ST.21.019.8D2700	19	2400	2700K	>80	IP 20	15°, 20°, 35°, 50°, 65°	1,1kg
TRC3ST.21.019.8D3000	19	2400	3000K	>80	IP 20	15°, 20°, 35°, 50°, 65°	1,1kg
TRC3ST.21.019.8D4000	19	2500	4000K	>80	IP 20	15°, 20°, 35°, 50°, 65°	1,1kg
TRC3ST.21.019.8D5000	19	2500	5000K	>80	IP 20	15°, 20°, 35°, 50°, 65°	1,1kg
TRC3ST.21.019.8E2000	19	1550	2000K	>80	IP 20	15°, 20°, 35°, 50°, 65°	1,1kg
TRC3ST.21.019.8E2500	19	2100	2500K	>80	IP 20	15°, 20°, 35°, 50°, 65°	1,1kg
TRC3ST.21.019.9D2700	19	2150	2700K	>90	IP 20	15°, 20°, 35°, 50°, 65°	1,1kg
TRC3ST.21.019.9D3000	19	2150	3000K	>90	IP 20	15°, 20°, 35°, 50°, 65°	1,1kg
TRC3ST.21.019.9D4000	19	2250	4000K	>90	IP 20	15°, 20°, 35°, 50°, 65°	1,1kg
TRC3ST.21.019.9E3000	19	1950	3000K	>90	IP 20	15°, 20°, 35°, 50°, 65°	1,1kg
TRC3ST.21.019.9E4200	19	1750	4200K	>90	IP 20	15°, 20°, 35°, 50°, 65°	1,1kg
TRC3ST.21.019.9E5700	19	2250	5700K	>90	IP 20	15°, 20°, 35°, 50°, 65°	1,1kg
TRC3ST.21.019.9F3000	19	2000	3000K	>90	IP 20	15°, 20°, 35°, 50°, 65°	1,1kg
TRC3ST.21.019.9G3000	19	2250	3000K	>90	IP 20	15°, 20°, 35°, 50°, 65°	1,1kg
TRC3ST.21.019.9G3500	19	2300	3500K	>90	IP 20	15°, 20°, 35°, 50°, 65°	1,1kg
TRC3ST.21.019.9G4000	19	2400	4000K	>90	IP 20	15°, 20°, 35°, 50°, 65°	1,1kg

Tracklight LED 3.1 3

							
TRC3ST.31.021.8D2700	21	1700	2700K	>80	IP 20	15°, 20°, 35°, 50°, 65°	1,1kg
TRC3ST.31.021.8D3000	21	1700	3000K	>80	IP 20	15°, 20°, 35°, 50°, 65°	1,1kg
TRC3ST.31.021.8D4000	21	1750	4000K	>80	IP 20	15°, 20°, 35°, 50°, 65°	1,1kg
TRC3ST.31.021.8D5000	21	1750	5000K	>80	IP 20	15°, 20°, 35°, 50°, 65°	1,1kg
TRC3ST.31.021.8E2000	21	1100	2000K	>80	IP 20	15°, 20°, 35°, 50°, 65°	1,1kg
TRC3ST.31.021.8E2500	21	1500	2500K	>80	IP 20	15°, 20°, 35°, 50°, 65°	1,1kg
TRC3ST.31.021.9D2700	21	1500	2700K	>90	IP 20	15°, 20°, 35°, 50°, 65°	1,1kg
TRC3ST.31.021.9D3000	21	1500	3000K	>90	IP 20	15°, 20°, 35°, 50°, 65°	1,1kg
TRC3ST.31.021.9D4000	21	1550	4000K	>90	IP 20	15°, 20°, 35°, 50°, 65°	1,1kg
TRC3ST.31.021.9E3000	21	1400	3000K	>90	IP 20	15°, 20°, 35°, 50°, 65°	1,1kg
TRC3ST.31.021.9E4200	21	1250	4200K	>90	IP 20	15°, 20°, 35°, 50°, 65°	1,1kg
TRC3ST.31.021.9E5700	21	1600	5700K	>90	IP 20	15°, 20°, 35°, 50°, 65°	1,1kg
TRC3ST.31.021.9F3000	21	1400	3000K	>90	IP 20	15°, 20°, 35°, 50°, 65°	1,1kg
TRC3ST.31.021.9G3000	21	1600	3000K	>90	IP 20	15°, 20°, 35°, 50°, 65°	1,1kg
TRC3ST.31.021.9G3500	21	1650	3500K	>90	IP 20	15°, 20°, 35°, 50°, 65°	1,1kg
TRC3ST.31.021.9G4000	21	1700	4000K	>90	IP 20	15°, 20°, 35°, 50°, 65°	1,1kg



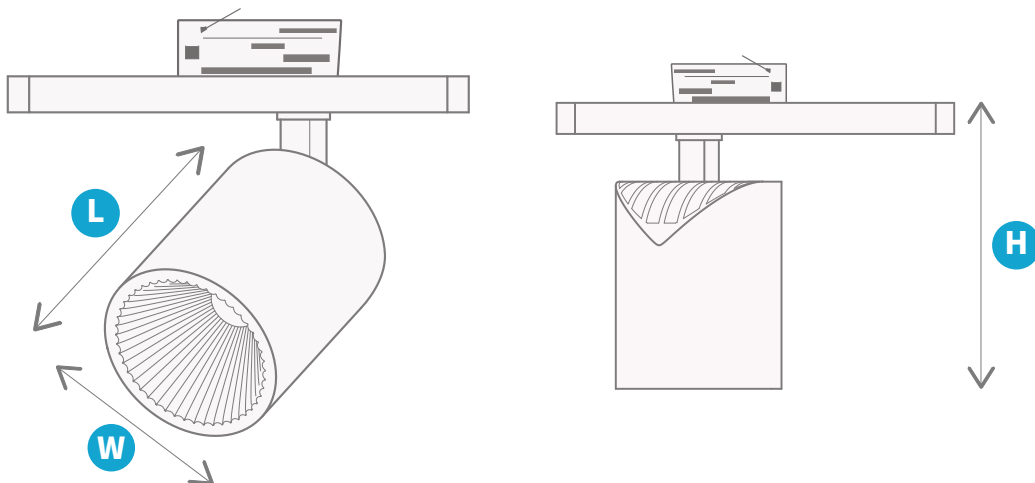

Tracklight LED 3.1 4

							
TRC3ST.41.023.8D2700	23	2900	2700K	>80	IP 20	15°, 20°, 35°, 50°, 65°	1,1kg
TRC3ST.41.023.8D3000	23	2900	3000K	>80	IP 20	15°, 20°, 35°, 50°, 65°	1,1kg
TRC3ST.41.023.8D4000	23	3000	4000K	>80	IP 20	15°, 20°, 35°, 50°, 65°	1,1kg
TRC3ST.41.023.8D5000	23	3000	5000K	>80	IP 20	15°, 20°, 35°, 50°, 65°	1,1kg
TRC3ST.41.023.8E2000	23	1800	2000K	>80	IP 20	15°, 20°, 35°, 50°, 65°	1,1kg
TRC3ST.41.023.8E2500	23	2500	2500K	>80	IP 20	15°, 20°, 35°, 50°, 65°	1,1kg
TRC3ST.41.023.9D2700	23	2600	2700K	>90	IP 20	15°, 20°, 35°, 50°, 65°	1,1kg
TRC3ST.41.023.9D3000	23	2600	3000K	>90	IP 20	15°, 20°, 35°, 50°, 65°	1,1kg
TRC3ST.41.023.9D4000	23	2700	4000K	>90	IP 20	15°, 20°, 35°, 50°, 65°	1,1kg
TRC3ST.41.023.9E3000	23	2300	3000K	>90	IP 20	15°, 20°, 35°, 50°, 65°	1,1kg
TRC3ST.41.023.9E4200	23	2100	4200K	>90	IP 20	15°, 20°, 35°, 50°, 65°	1,1kg
TRC3ST.41.023.9E5700	23	2700	5700K	>90	IP 20	15°, 20°, 35°, 50°, 65°	1,1kg
TRC3ST.41.023.9F3000	23	2050	3000K	>90	IP 20	15°, 20°, 35°, 50°, 65°	1,1kg
TRC3ST.41.023.9G3000	23	2350	3000K	>90	IP 20	15°, 20°, 35°, 50°, 65°	1,1kg
TRC3ST.41.023.9G3500	23	2400	3500K	>90	IP 20	15°, 20°, 35°, 50°, 65°	1,1kg
TRC3ST.41.023.9G4000	23	2550	4000K	>90	IP 20	15°, 20°, 35°, 50°, 65°	1,1kg

Wymiarowanie i Logistyka



	H	L	W
TRC3ST	143	96	Ø 84

			
TRC3ST	1	128	120x80

Montaż

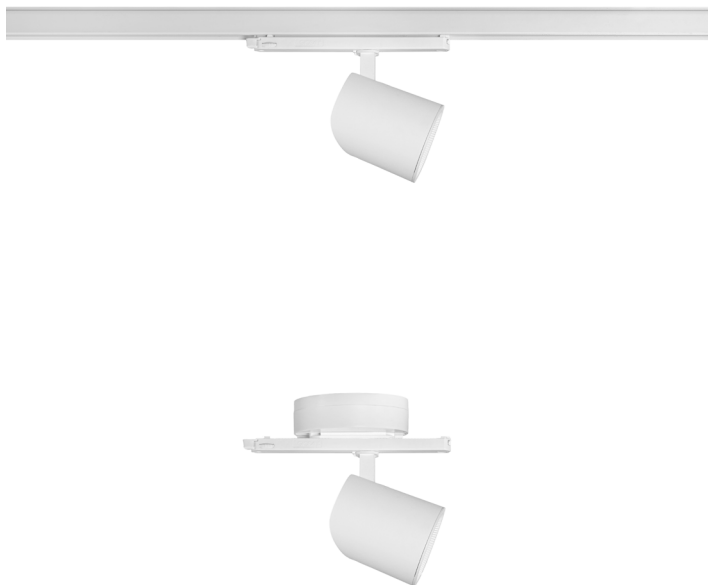

szyna 3-fazowa

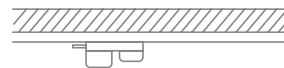

adapter natynkowy



Rozsył Światłości

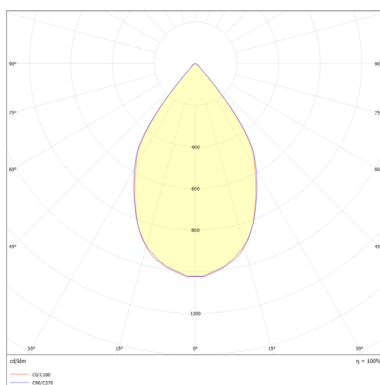
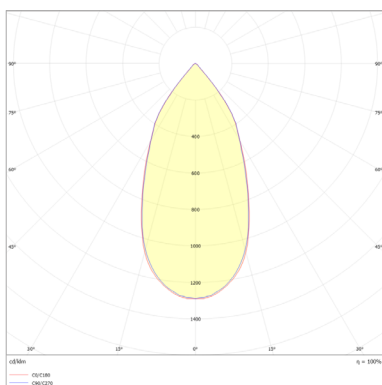
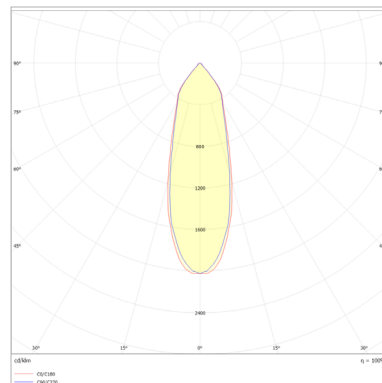
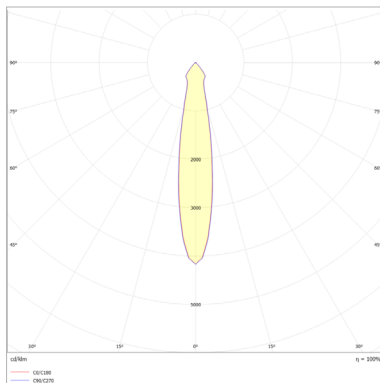
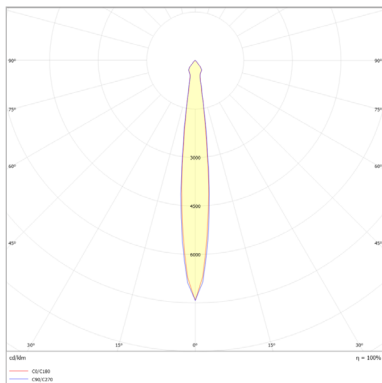

Dostępne konfiguracje

Rodzina	Wersja mocowa	Wersja	Moc [W]	CRI	Typ diody	CCT [K]	Materiał soczewki	Materiał dyfuzora	Rozsył	Sterowanie	Temperatury pracy [°C]	Gwarancja	Modyfikacje
TRC3ST Tracklight LED 3	1	1 Lift 1	013	8	D	2000	0 Nie występuje	S35 Reflektor ABS polyskliwe	020020	00 ON/OFF	2035 -25 °C + 35 °C	05Y 5 lat	B001 Czarny, RAL9005
			019	9	E	2500			035035				W001 Biały, RAL9016
			021	>90	COB Pożywienie/ Specjalne aplik.	2700			050050				
			023	F	2700K	065065							
			023	G	3000	3000K			65°x65°				
			023	G	3500	3500K							
			023	G	4000	4000K							
			023	G	4200	4200K							
			023	G	5000	5000K							
			023	G	5700	5700K							

TRC3ST.11.013.8D2700.0S35.020020.00.2035.05Y.W001

Przykładowy kod produktu: