



# ULTIMA: LED 3.0 DBL HPT

## Vorteile

- Hohe Lichtausbeute bis 159 lm/W
- Diffusor aus gehärtetem Glas oder Polycarbonat
- Schutzart IP65
- Umgebungstemperatur: -35°C bis +70°C  
(Version IV bis + 65°C)



### Ultima LED 3.0 DBL HPT III

|                      | P   | lm    | K     | Ra  | IP    |          |         |
|----------------------|-----|-------|-------|-----|-------|----------|---------|
| ULT3-DBL-III-WW-DGT  | 222 | 33300 | 3000K | >80 | IP 65 | 60°, 90° | 14,9 kg |
| ULT3-DBL-III-NW-DGT  | 222 | 35100 | 4000K | >80 | IP 65 | 60°, 90° | 14,9 kg |
| ULT3-DBL-III-DW-DGT  | 222 | 35200 | 5000K | >80 | IP 65 | 60°, 90° | 14,9 kg |
| ULT3-DBL-III-WW-DTPC | 222 | 32080 | 3000K | >80 | IP 65 | 60°, 90° | 13,3 kg |
| ULT3-DBL-III-NW-DTPC | 222 | 33800 | 4000K | >80 | IP 65 | 60°, 90° | 13,3 kg |
| ULT3-DBL-III-DW-DTPC | 222 | 33900 | 5000K | >80 | IP 65 | 60°, 90° | 13,3 kg |



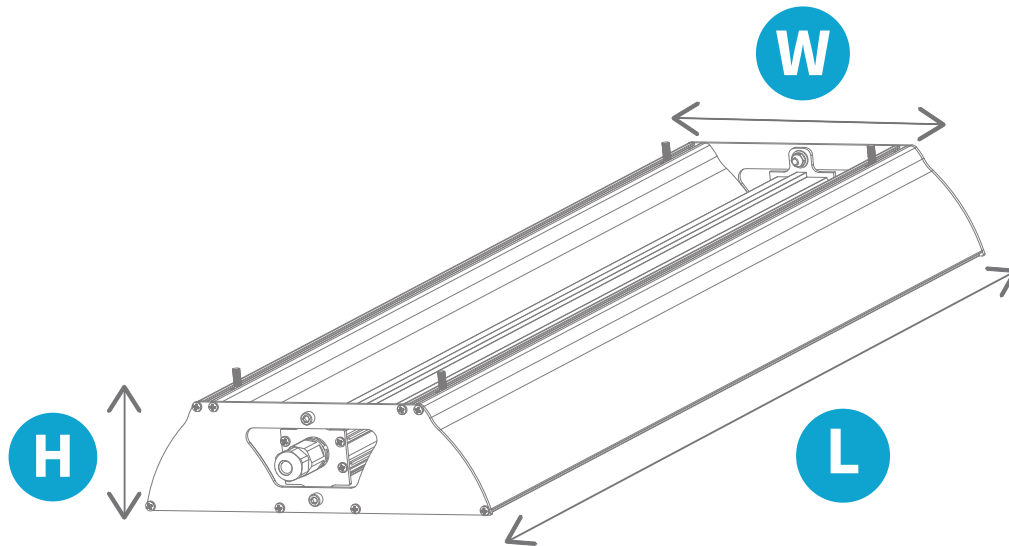

### Ultima LED 3.0 DBL HPT IV

|                     | P   | lm    | K     | Ra  | IP    |          |         |
|---------------------|-----|-------|-------|-----|-------|----------|---------|
| ULT3-DBL-IV-WW-DGT  | 290 | 42000 | 3000K | >80 | IP 65 | 60°, 90° | 14,9 kg |
| ULT3-DBL-IV-NW-DGT  | 290 | 44280 | 4000K | >80 | IP 65 | 60°, 90° | 14,9 kg |
| ULT3-DBL-IV-DW-DGT  | 290 | 44380 | 5000K | >80 | IP 65 | 60°, 90° | 14,9 kg |
| ULT3-DBL-IV-WW-DTPC | 290 | 40460 | 3000K | >80 | IP 65 | 60°, 90° | 13,3 kg |
| ULT3-DBL-IV-NW-DTPC | 290 | 42640 | 4000K | >80 | IP 65 | 60°, 90° | 13,3 kg |
| ULT3-DBL-IV-DW-DTPC | 290 | 42740 | 5000K | >80 | IP 65 | 60°, 90° | 13,3 kg |

# Abmessungen und Logistik



|  | H  | L    | W   |
|---|----|------|-----|
| ULT3-DBL-III  | 91 | 1375 | 269 |
| ULT3-DBL-IV   | 91 | 1375 | 269 |

|  |  |  |  |
|---|---|---|---|
| ULT3-DBL-III  | 2   | 22  | 160x80  |
| ULT3-DBL-IV   | 2   | 22  | 160x80  |

## Montageart

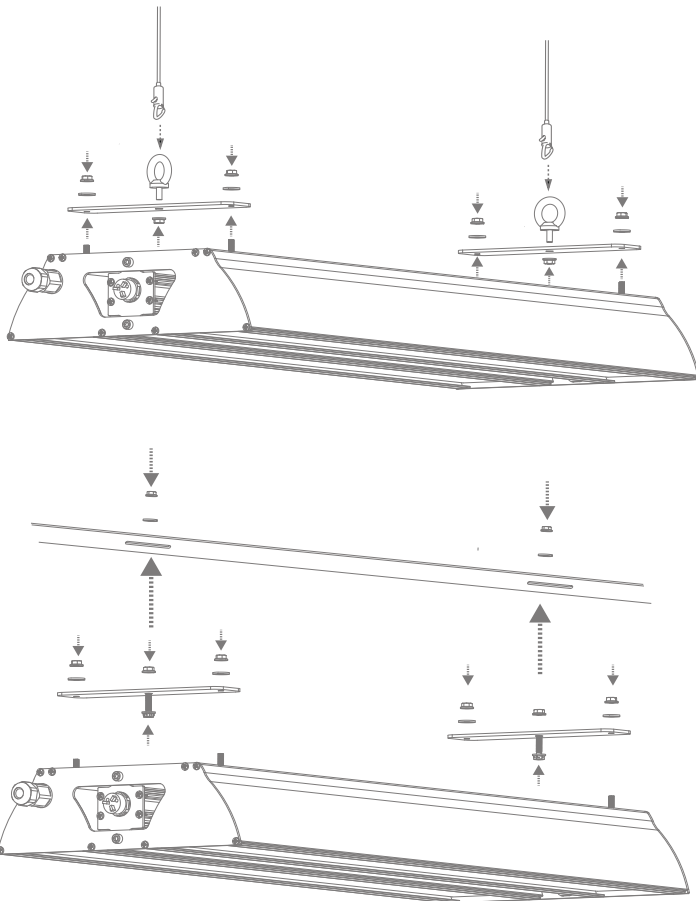

**Deckenaufbau**



**Seilabhängung**



# Lichtstärke

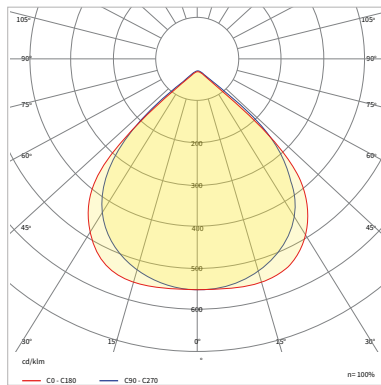
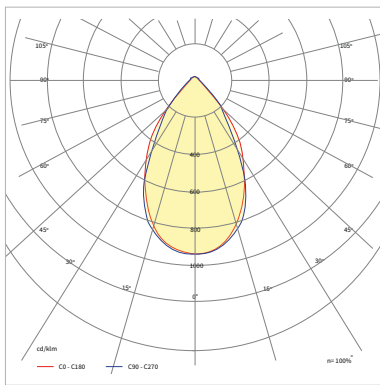

## Verfügbare Konfigurationen

ULT3-DBL-III  
ULT3-DBL-IV

NW  
1

60°  
2

DGT  
3

DALI  
4

HPT  
5

|                         |                            |                                  |                                      |
|-------------------------|----------------------------|----------------------------------|--------------------------------------|
| <b>Größe</b>            | III                        | IV                               |                                      |
| <b>1 Farbtemperatur</b> | <b>WW</b> 3000K            | <b>NW</b> 4000K                  | <b>DW</b> 5000K                      |
| <b>2 Optik</b>          | <b>60°</b> Abstrahlwinkel  | <b>90°</b> Abstrahlwinkel        |                                      |
| <b>3 Diffusor*</b>      | <b>DGT</b> Gehärtetes Glas | <b>DGF</b> Gehärtetes Glas Frost | <b>DTPC</b> Polycarbonat Transparent |
| <b>4 Steuerung</b>      | <b>DALI</b> DALI           |                                  |                                      |

\* DGT - IK06, DGF - IK06, DTPC - IK10