

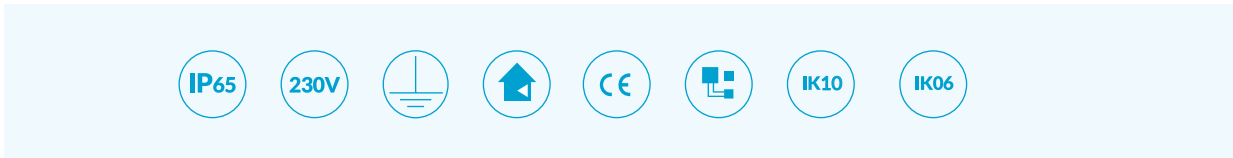

ULTIMA LED 3.0

Vorteile

- Hohe Lichtausbeute 172 lm/W
- Garantie 10 Jahren
- Diffusor aus gehärtetem Glas oder PMMA
- Weiter Betriebstemperaturbereich
- Hohe Schlagfestigkeit IK10



Ultima LED 3.0 1

ULT3ST.10.021.8A4000	21	3250 - 3400	4000K	>80	IP65	65°X60° 95°X90° 100°X110° 115°X120°	2kg
ULT3ST.10.021.8A5000	21	3300 - 3450	5000K	>80	IP65	65°X60° 95°X90° 100°X110° 115°X120°	2kg

Ultima LED 3.0 2

ULT3ST.20.042.8A4000	42	6600 - 6900	4000K	>80	IP65	65°X60° 95°X90° 100°X110° 115°X120°	3,3kg
ULT3ST.20.042.8A5000	42	6650 - 6950	5000K	>80	IP65	65°X60° 95°X90° 100°X110° 115°X120°	3,3kg

Ultima LED 3.0 3







ULT3ST.30.053.8A4000	53	8700 - 9100	4000K	>80	IP65	65°X60° 95°X90° 100°X110° 115°X120°	4,3kg
ULT3ST.30.053.8A5000	53	8750 - 9150	5000K	>80	IP65	65°X60° 95°X90° 100°X110° 115°X120°	4,3kg

Ultima LED 3.0 4









ULT3ST.40.083.8A4000	83	12700 - 13300	4000K	>80	IP65	65°X60° 95°X90° 100°X110° 115°X120°	4,3kg
ULT3ST.40.083.8A5000	83	12750 - 13350	5000K	>80	IP65	65°X60° 95°X90° 100°X110° 115°X120°	4,3kg

Um die Lichtparameter für den ausgewählten Abstrahlwinkel genau zu kennen, verwenden Sie bitte photometrische Dateien für den angegebenen Abstrahlwinkel. Download-Link: luxon.pl/Pliki/LDT-LUXON-LED-2020.zip









Ultima LED 3.0 5

		 min-max					
ULT3ST.50.110.8A4000	110	17000 - 17800	4000K	>80	IP65	65°X60° 95°X90° 100°X110° 115°X120°	5,5kg
ULT3ST.50.110.8A5000	110	17050 - 17850	5000K	>80	IP65	65°X60° 95°X90° 100°X110° 115°X120°	5,5kg







Ultima LED 3.0 6

		 min-max					
ULT3ST.60.145.8A4000	145	21600 - 22600	4000K	>80	IP65	65°X60° 95°X90° 100°X110° 115°X120°	5,5kg
ULT3ST.60.145.8A5000	145	21650 - 22650	5000K	>80	IP65	65°X60° 95°X90° 100°X110° 115°X120°	5,5kg

Ultima LED 3.0 7

		 min-max					
ULT3ST.70.195.8A4000	195	29550 - 30900	4000K	>80	IP65	65°X60° 95°X90° 100°X110° 115°X120°	8,2kg
ULT3ST.70.195.8A5000	195	29600 - 30950	5000K	>80	IP65	65°X60° 95°X90° 100°X110° 115°X120°	8,2kg

Ultima LED 3.0 8



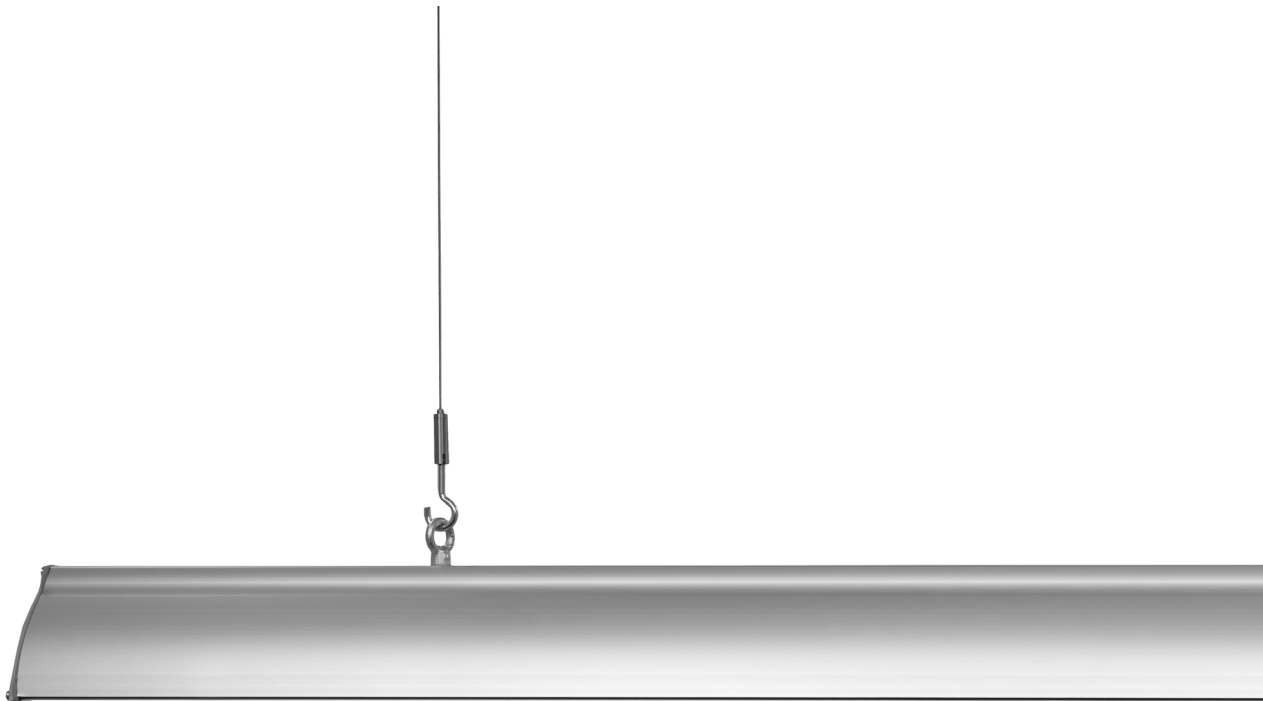

		 min-max					
ULT3ST.80.260.8A4000	260	39500 - 41300	4000K	>80	IP65	65°X60° 95°X90° 100°X110° 115°X120°	10,5kg
ULT3ST.80.260.8A5000	260	39550 - 41350	5000K	>80	IP65	65°X60° 95°X90° 100°X110° 115°X120°	10,5kg

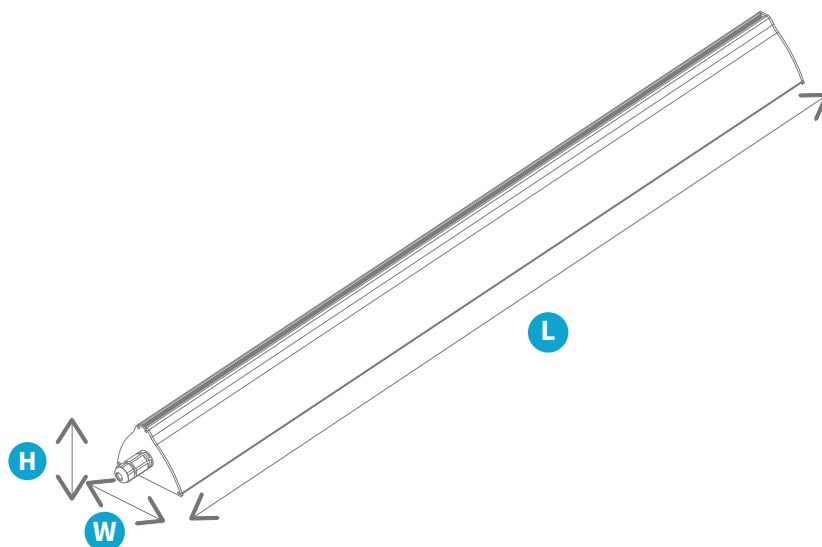

Abmessungen und Logistik



	H	L	W
ULT3ST.1	91	408	126
ULT3ST.2	91	708	126
ULT3ST.3	91	978	126
ULT3ST.4	91	978	126
ULT3ST.5	91	1275	126
ULT3ST.6	91	1275	126
ULT3ST.7	91	1878	126
ULT3ST.8	91	2458	126

			
ULT3ST.1	4	34	120x80
ULT3ST.2	4	34	120x80
ULT3ST.3	4	54	120x80
ULT3ST.4	4	54	120x80
ULT3ST.5	4	50	130x80
ULT3ST.6	4	50	130x80
ULT3ST.7	3	40	200x80
ULT3ST.8	2	36	300x80

Montageart

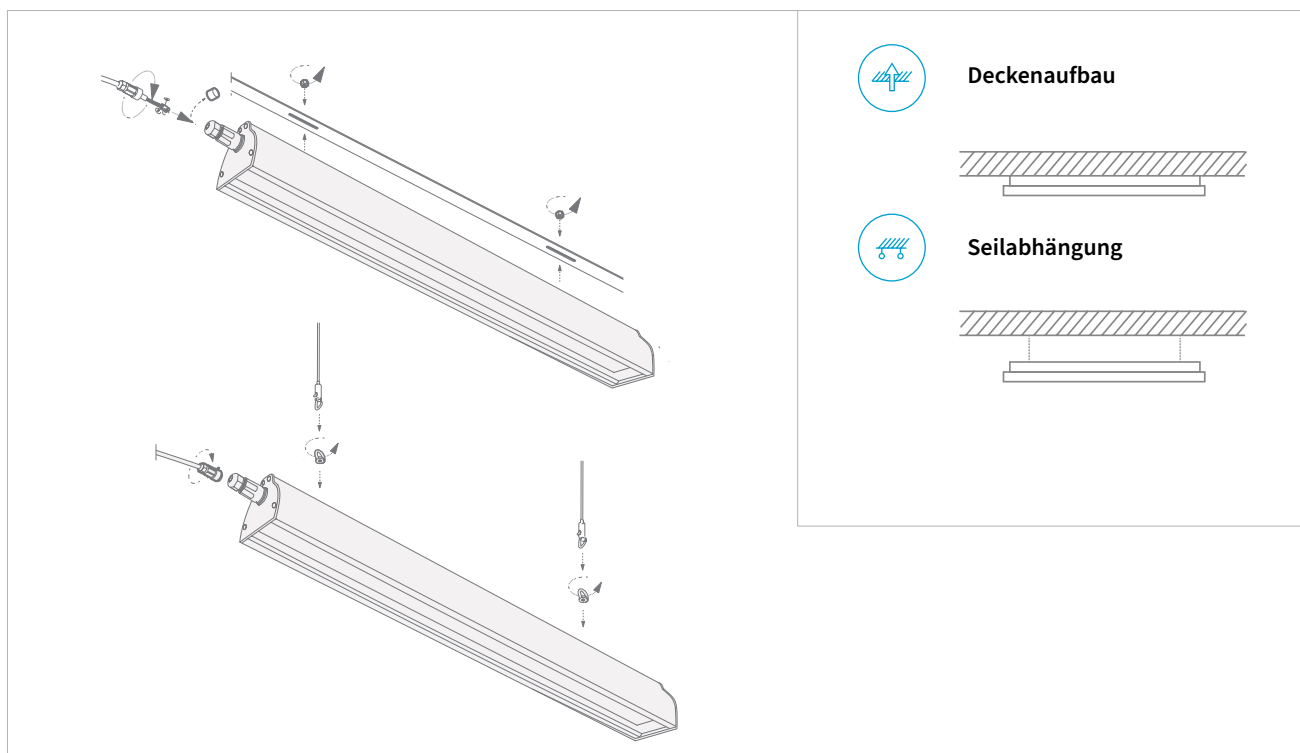

Lichtstärke

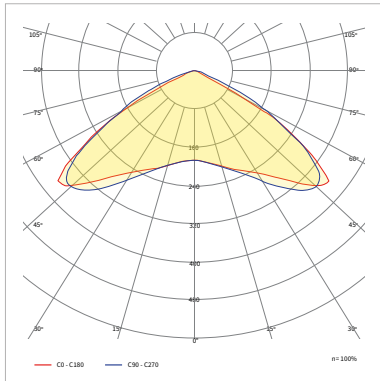
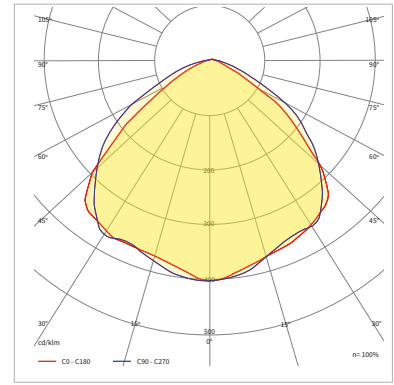
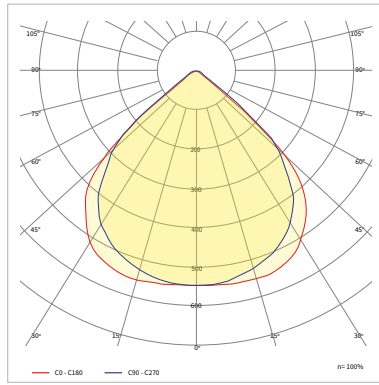
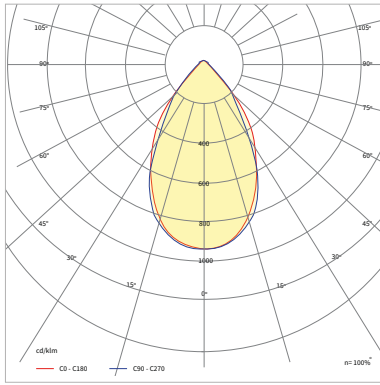

Verfügbare Konfigurationen:

Familie	Leistungs- version	Version	Nennleistung [W]	CRI	Typ der Diode	CCT [K]	Material der Linse	Material des Diffusors	Abstrahl- winkel	Lichtsteu- erung	Betriebstem- peratur [°C]	Garantie	Modifika- tionen	
ULT3ST Ultima LED 3	1	0 Standard	021	8 >80	A Mid Power	4000	1 PMMA	P11 PMMA transparent	065060	00 ON/OFF	2040	05Y 5 Jahre	E001 Durchgan- gsversion	
	1		21W			4000K			65°x60°		-20°C+40°C			
	2		042			42W	5000	G11 Gehärtetes Glas transparent	095090	D0	2045	08Y	8 Jahre	F004 Outdoor Version
	2		42W			5000K	95°x90°		DALI	-20°C+45°C	10Y	10 Jahre		
	3		053			53W	100°x110°	S1	2050	Bewegun- gsmelder	-20°C+50°C	2540	-25°C+40°C	
	3		53W			115°x120°		-25°C+45°C						
	4		083			83W	-25°C+55°C	3545	-35°C+45°C					
	4		83W			3550		-35°C+50°C						
5	110	110W	3560	-35°C+60°C										
6	145	145W												
7	195	195W												
8	260	260W												

Beispiel-Produktcode:

ULT3ST.60.145.8A5000.1P11.065060.00.2540.10Y.E001