

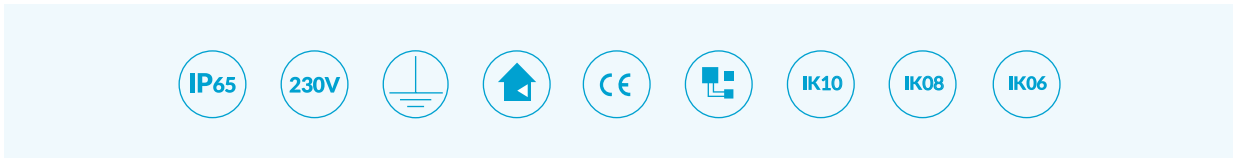

ULTIMA:LED 3.0

Advantages

- High luminous efficacy up to 170 lm/W
- Warranty up to 10 years
- Tempered glass or PMMA diffuser
- Operates at ambient temperatures: - 25°C to + 55°C (I - up to 55°C, MINI I / II up to 50°C, II / III / V - up to 45°C, IV / VI - up to 40°C)
- PRO variant with a 10-year warranty or the ability to work at ambient temperatures: - 35°C to + 60°C



Ultima:LED 3.0 MINI I

ULT3-MINI-I-WW	21	3250	3000K	>80	65	60°, 90°	1,8kg
ULT3-MINI-I-NW	21	3450	4000K	>80	65	60°, 90°	1,8kg
ULT3-MINI-I-DW	21	3500	5000K	>80	65	60°, 90°	1,8kg

Ultima:LED 3.0 MINI II

ULT3-MINI-II-WW	42	6500	3000K	>80	65	60°, 90°	2,8kg
ULT3-MINI-II-NW	42	6900	4000K	>80	65	60°, 90°	2,8kg
ULT3-MINI-II-DW	42	6950	5000K	>80	65	60°, 90°	2,8kg

Ultima:LED 3.0 I









ULT3-I-WW	53	8750	3000K	>80	65	60°, 90°	4,4kg
ULT3-I-NW	53	9200	4000K	>80	65	60°, 90°	4,4kg
ULT3-I-DW	53	9250	5000K	>80	65	60°, 90°	4,4kg

Ultima:LED 3.0 II









ULT3-II-WW	83	12900	3000K	>80	65	60°, 90°	4,4kg
ULT3-II-NW	83	13650	4000K	>80	65	60°, 90°	4,4kg
ULT3-II-DW	83	13700	5000K	>80	65	60°, 90°	4,4kg

In order to know exact the light parameters for selected beam angle, please use photometric files for the given beam angle. Download link: luxon.pl/Pliki/LDT-LUXON-LED-2020.zip









Ultima:LED 3.0 III

							
ULT3-III-WW	110	17050	3000K	>80	65	60°, 90°	6,1kg
ULT3-III-NW	110	18100	4000K	>80	65	60°, 90°	6,1kg
ULT3-III-DW	110	18150	5000K	>80	65	60°, 90°	6,1kg









Ultima:LED 3.0 IV

							
ULT3-IV-WW	145	21450	3000K	>80	65	60°, 90°	6,1kg
ULT3-IV-NW	145	22750	4000K	>80	65	60°, 90°	6,1kg
ULT3-IV-DW	145	22800	5000K	>80	65	60°, 90°	6,1kg

Ultima:LED 3.0 V

							
ULT3-V-WW	195	29750	3000K	>80	65	60°, 90°	9,3kg
ULT3-V-NW	195	31350	4000K	>80	65	60°, 90°	9,3kg
ULT3-V-DW	195	31400	5000K	>80	65	60°, 90°	9,3kg

Ultima:LED 3.0 VI



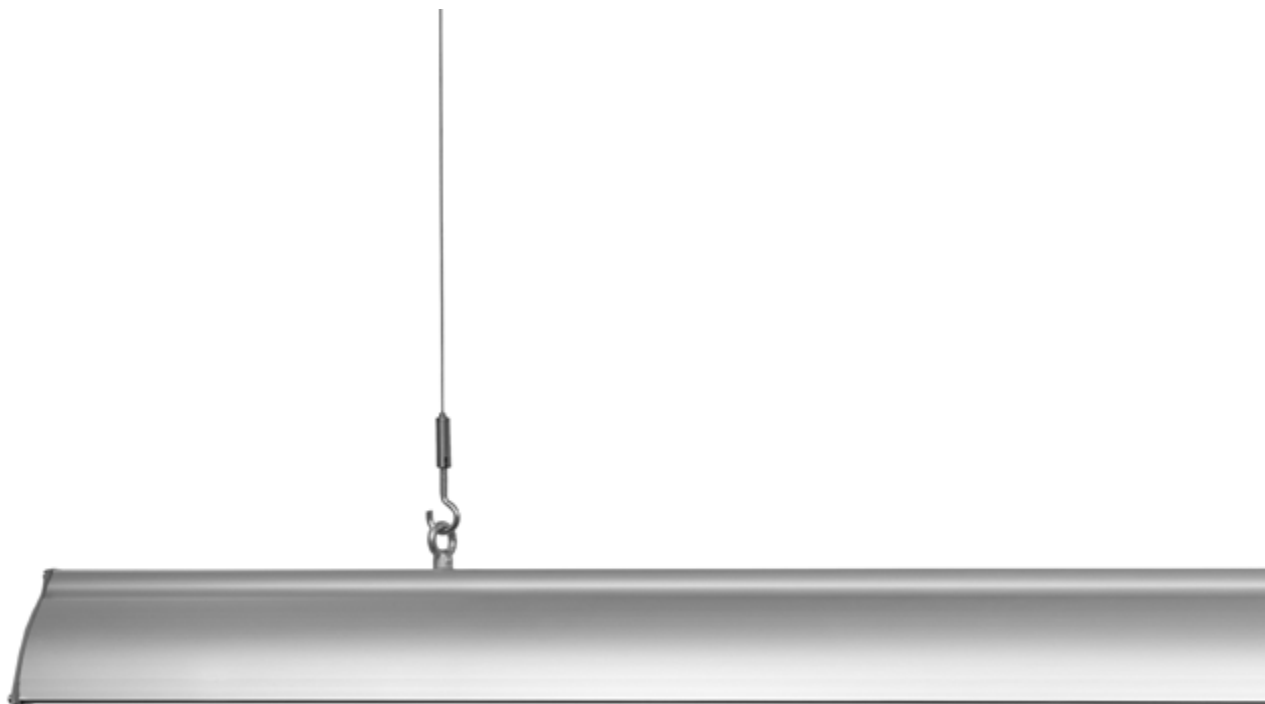

							
ULT3-VI-WW	260	39800	3000K	>80	65	60°, 90°	12kg
ULT3-VI-NW	260	41950	4000K	>80	65	60°, 90°	12kg
ULT3-VI-DW	260	42000	5000K	>80	65	60°, 90°	12kg

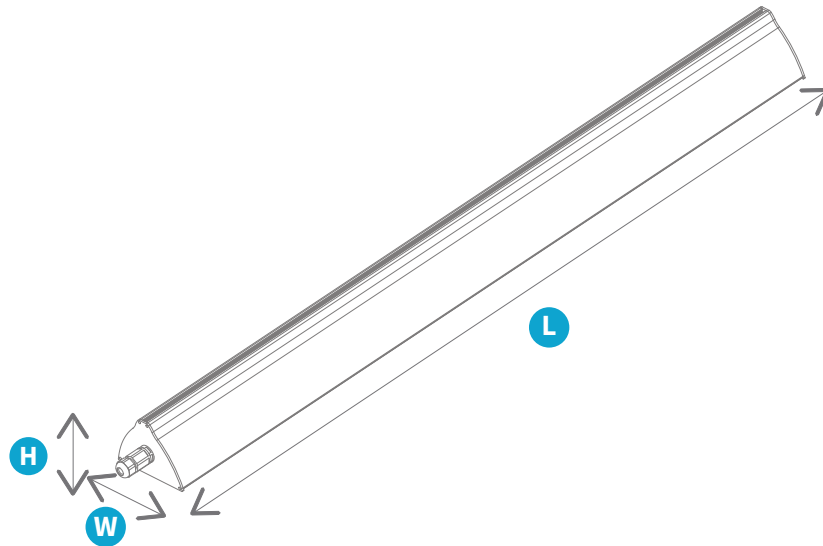

Dimensions and Logistics



	H	L	W
ULT3-MINI-I	93	408	123
ULT3-MINI-II	93	708	123
ULT3-I	91	978	126
ULT3-II	91	978	126
ULT3-III	91	1275	126
ULT3-IV	91	1275	126
ULT3-V	91	1878	126
ULT3-VI	91	2458	126

			
ULT3-MINI-I	4	34	120x80
ULT3-MINI-II	4	34	120x80
ULT3-I	4	54	120x80
ULT3-II	4	54	120x80
ULT3-III	4	50	130x80
ULT3-IV	4	50	130x80
ULT3-V	3	40	200x80
ULT3-VI	2	36	300x80

Montage

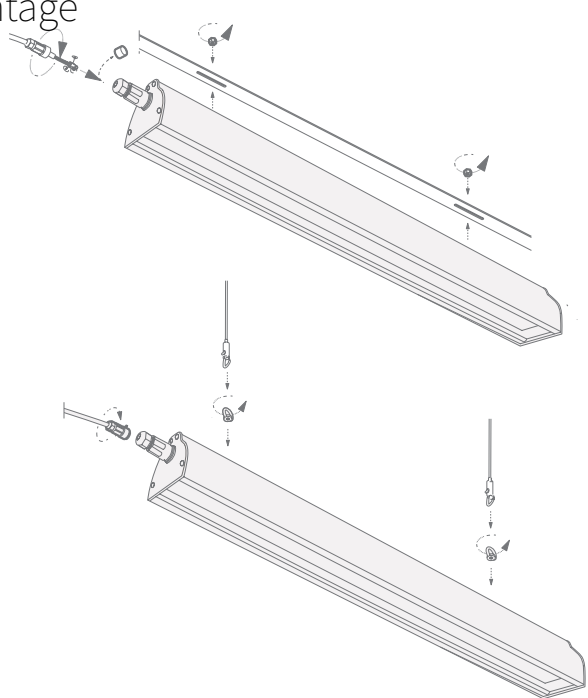



surface mounting

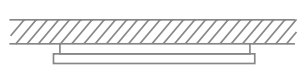



suspended

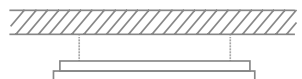

Luminous Intensity Distribution

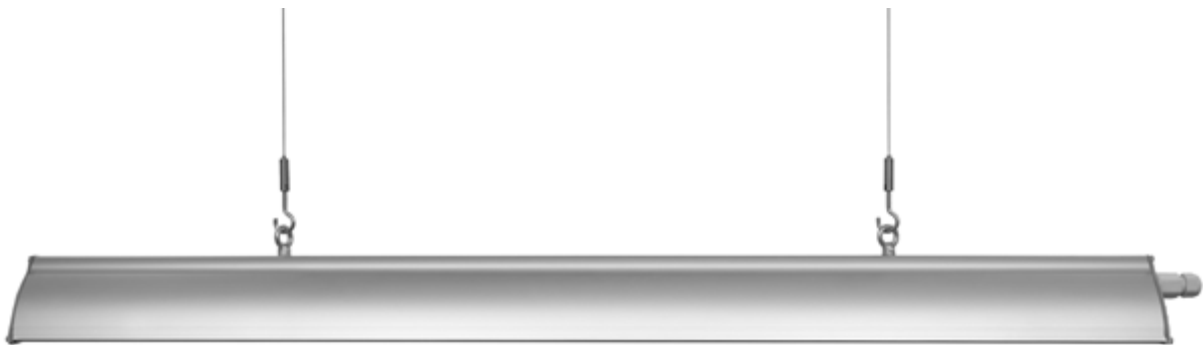
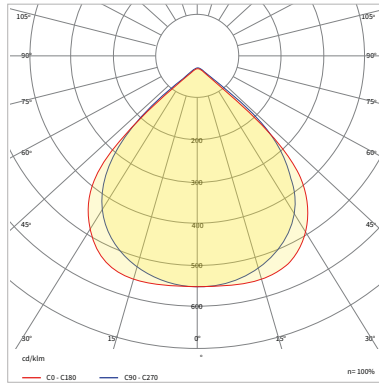
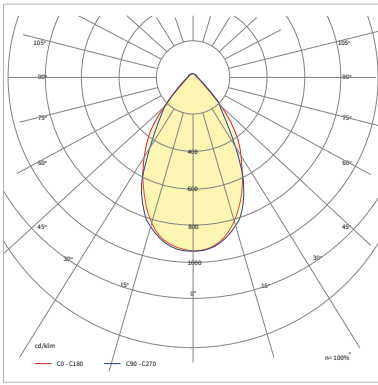

Available Configurations

ULT3-MINI-I / II
ULT3-I/II/III/IV/V/VI



Size	I	II	III	IV	V	VI
1 Color Temperature	WW 3000K		NW 4000K		DW 5000K	
2 Optics	60° Beam Angle		90° Beam Angle			
3 Diffuser*	DT Transparent PMMA		DF Frost diffuser		DGT Transparent Glass	
					DGF Frost Glass	
4 Controls	DALI DALI		HF Proximity sensor			
5 Extras	96M 8 years warranty		120M 10 years warranty		PRO -35°C/+60°C (M, I, II) -35°C/+50°C (II, III, V) -35°C/+45°C (IV, VI)	
	TW Through wiring		OUT Outdoor			

* **DT - IK10, DF - IK08, DGT - IK06, DGF - IK06**