

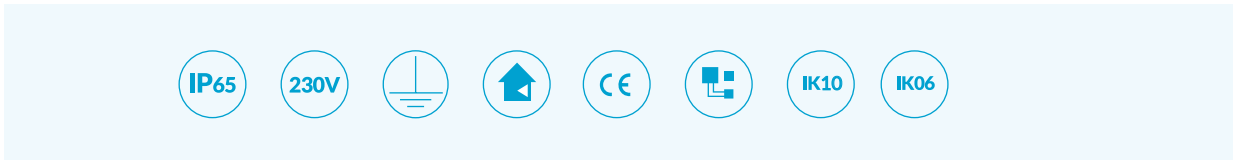

ULTIMA LED 3.0

Przewagi

- Wysoka skuteczność świetlna do 172 lm/W
- Gwarancja 10 lat
- Dyfuzor ze szkła hartowanego lub PMMA
- Szeroki zakres temperatur pracy
- Wysoka odporność na uderzenia IK10



Ultima LED 3.0 1

ULT3ST.10.021.8A4000	21	3250 - 3400	4000K	>80	IP65	65°X60° 95°X90° 100°X110° 115°X120°	2kg
ULT3ST.10.021.8A5000	21	3300 - 3450	5000K	>80	IP65	65°X60° 95°X90° 100°X110° 115°X120°	2kg

Ultima LED 3.0 2

ULT3ST.20.042.8A4000	42	6600 - 6900	4000K	>80	IP65	65°X60° 95°X90° 100°X110° 115°X120°	3,3kg
ULT3ST.20.042.8A5000	42	6650 - 6950	5000K	>80	IP65	65°X60° 95°X90° 100°X110° 115°X120°	3,3kg

Ultima LED 3.0 3







ULT3ST.30.053.8A4000	53	8700 - 9100	4000K	>80	IP65	65°X60° 95°X90° 100°X110° 115°X120°	4,3kg
ULT3ST.30.053.8A5000	53	8750 - 9150	5000K	>80	IP65	65°X60° 95°X90° 100°X110° 115°X120°	4,3kg

Ultima LED 3.0 4









ULT3ST.40.083.8A4000	83	12700 - 13300	4000K	>80	IP65	65°X60° 95°X90° 100°X110° 115°X120°	4,3kg
ULT3ST.40.083.8A5000	83	12750 - 13350	5000K	>80	IP65	65°X60° 95°X90° 100°X110° 115°X120°	4,3kg

W celu zapoznania się z parametrami świetlnymi, dla danego kąta rozsyłu światłości prosimy o posługiwanie się plikami fotometrycznymi. Link do pobrania: luxon.pl/Pliki/LDT-LUXON-LED-2020.zip









Ultima LED 3.0 5

		 min-max					
ULT3ST.50.110.8A4000	110	17000 - 17800	4000K	>80	IP65	65°X60° 95°X90° 100°X110° 115°X120°	5,5kg
ULT3ST.50.110.8A5000	110	17050 - 17850	5000K	>80	IP65	65°X60° 95°X90° 100°X110° 115°X120°	5,5kg









Ultima LED 3.0 6

		 min-max					
ULT3ST.60.145.8A4000	145	21600 - 22600	4000K	>80	IP65	65°X60° 95°X90° 100°X110° 115°X120°	5,5kg
ULT3ST.60.145.8A5000	145	21650 - 22650	5000K	>80	IP65	65°X60° 95°X90° 100°X110° 115°X120°	5,5kg

Ultima LED 3.0 7

		 min-max					
ULT3ST.70.195.8A4000	195	29550 - 30900	4000K	>80	IP65	65°X60° 95°X90° 100°X110° 115°X120°	8,2kg
ULT3ST.70.195.8A5000	195	29600 - 30950	5000K	>80	IP65	65°X60° 95°X90° 100°X110° 115°X120°	8,2kg

Ultima LED 3.0 8



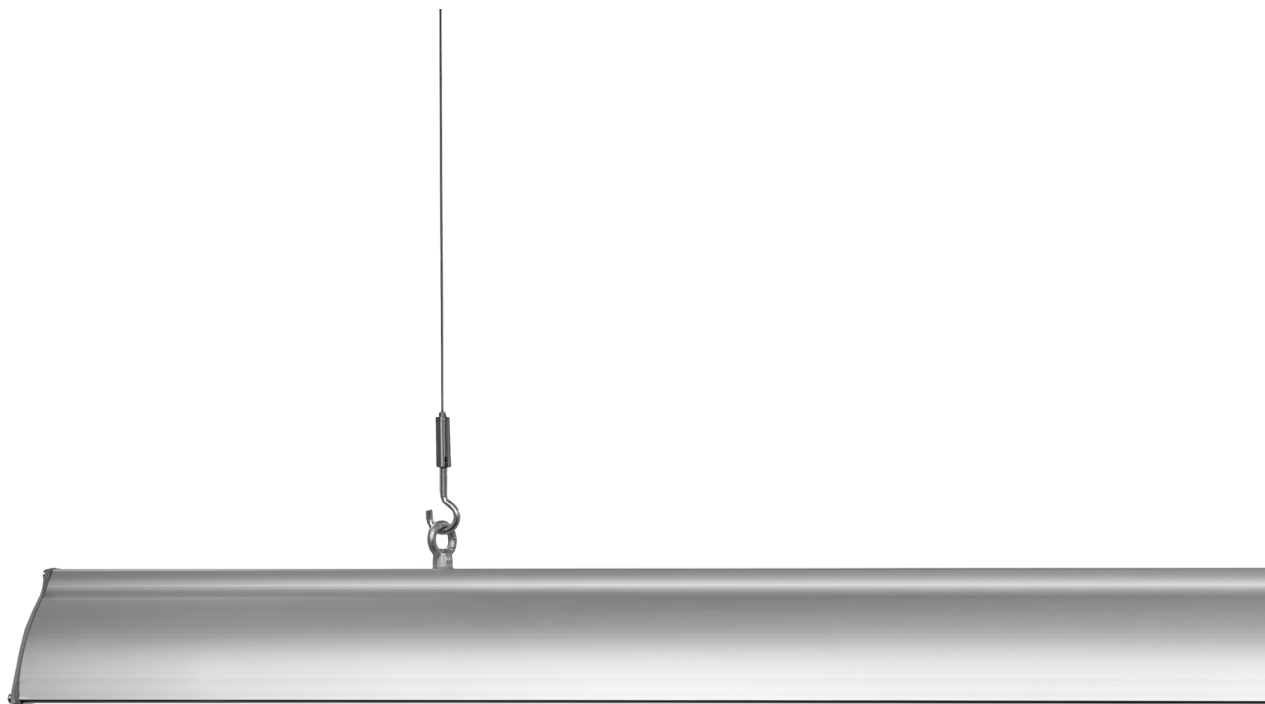

		 min-max					
ULT3ST.80.260.8A4000	260	39500 - 41300	4000K	>80	IP65	65°X60° 95°X90° 100°X110° 115°X120°	10,5kg
ULT3ST.80.260.8A5000	260	39550 - 41350	5000K	>80	IP65	65°X60° 95°X90° 100°X110° 115°X120°	10,5kg

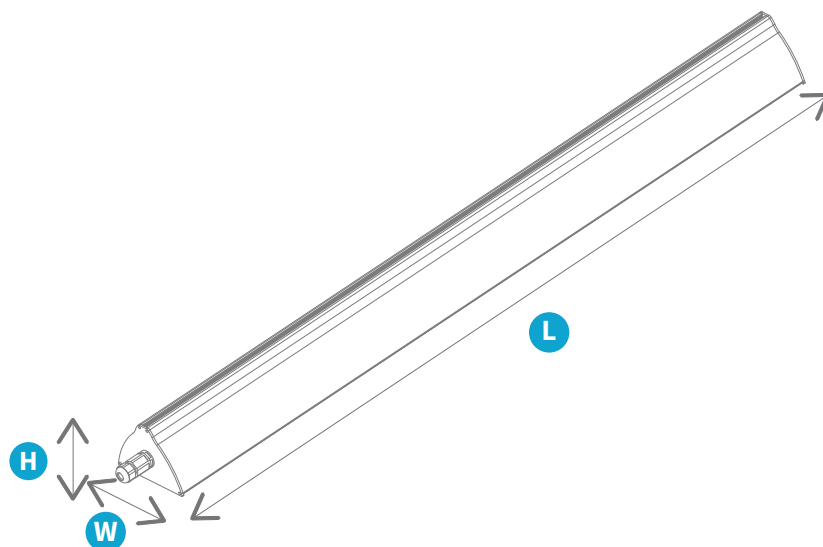

Wymiarowanie i Logistyka



	H	L	W
ULT3ST.1	91	408	126
ULT3ST.2	91	708	126
ULT3ST.3	91	978	126
ULT3ST.4	91	978	126
ULT3ST.5	91	1275	126
ULT3ST.6	91	1275	126
ULT3ST.7	91	1878	126
ULT3ST.8	91	2458	126

			
ULT3ST.1	4	34	120x80
ULT3ST.2	4	34	120x80
ULT3ST.3	4	54	120x80
ULT3ST.4	4	54	120x80
ULT3ST.5	4	50	130x80
ULT3ST.6	4	50	130x80
ULT3ST.7	3	40	200x80
ULT3ST.8	2	36	300x80

Montaż

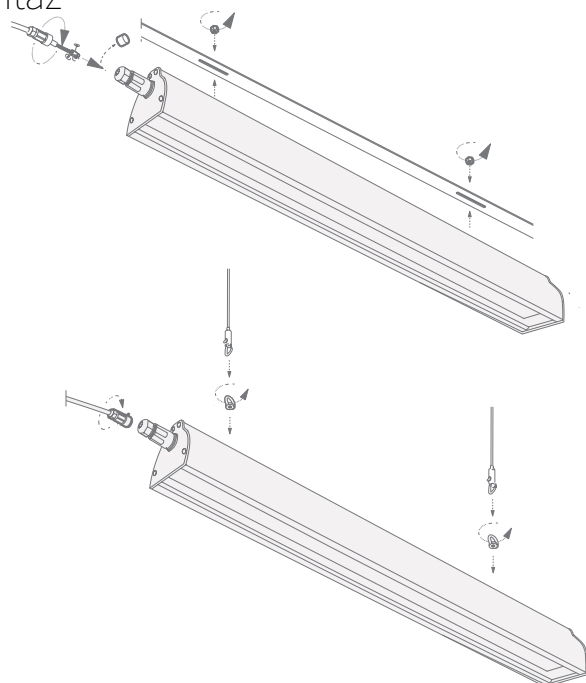

natynkowy

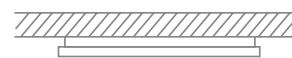

zwieszany

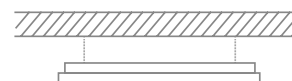

Rozsył Światłości

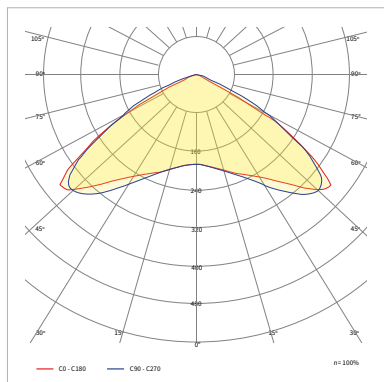
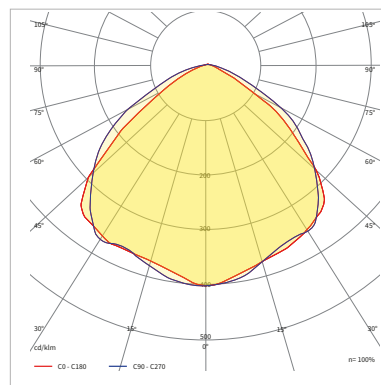
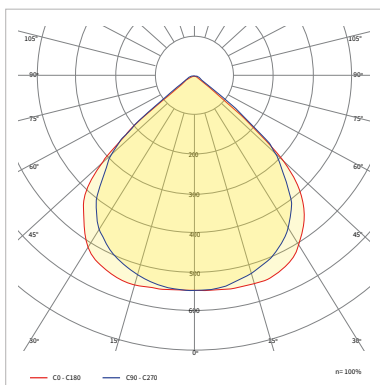
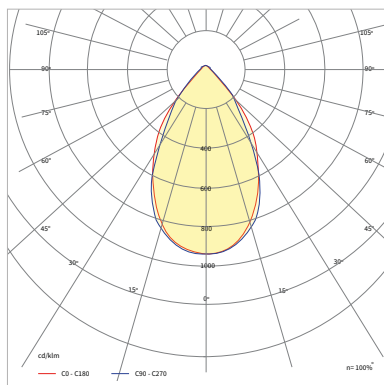

Dostępne konfiguracje

Rodzina	Wersja mocowa	Wersja	Moc [W]	CRI	Typ diody	CCT [K]	Materiał soczewki	Materiał dyfuzora	Rozsył	Sterowanie	Temperatury pracy [°C]	Gwarancja	Modyfikacje			
ULT3ST Ultima LED 3	1	0 Standard	021	8 >80	A Mid Power	4000	1 PMMA	P11 PMMA transparentne	065060	00 ON/OFF	2040	05Y 5 lat	0000 Standard			
	1		21W			4000K			65°x60°		-20°C÷40°C					
	2		042			5000			095090		D0 DALI			2045	08Y 8 lat	E001 wersja przelotowa
	2		42W			5000K			95°x90°		-20°C÷45°C					
	3		053			szkło hartowane transparentne			100110		S1 czujnik ruchu			2050	10Y 10 lat	F004 Wersja outdoor
	3		53W						100°x110°					-20°C÷50°C		
	4		083						115120					2540		2545
	4		83W						115°x120°					-25°C÷40°C		-25°C÷45°C
	5		110						2555					-25°C÷55°C		
5	110W	3545	-35°C÷45°C													
6	145	3550	-35°C÷60°C													
6	145W															
7	195															
7	195W															
8	260															
8	260W															

Przykładowy kod produktu:

ULT3ST.60.145.8A5000.1P11.065060.00.2540.10Y.E001