



ULTRA LED

Przewagi

- wysoka skuteczność świetlna do 197lm/W
- gwarancja do 10 lat
- smukła, kompaktowa obudowa
- zredukowany efekt olśnienia



Ultra LED 1.0 1

		min-max					
UTR1ST.10.035.8A3000	35	5850- 6200	3000K	>80	IP66	30°X50°, 50°, 70°, 80°, 85°	1,4kg
UTR1ST.10.035.8A4000	35	6050 - 6400	4000K	>80	IP66	30°X50°, 50°, 70°, 80°, 85°	1,4kg
UTR1ST.10.035.8A5000	35	6100 - 6450	5000K	>80	IP66	30°X50°, 50°, 70°, 80°, 85°	1,4kg









Ultra LED 1.0 2

UTR1ST.20.051.8A3000	51	8900- 9450	3000K	>80	IP66	30°X50°, 50°, 70°, 80°, 85°	2,4kg
UTR1ST.20.051.8A4000	51	9200- 9750	4000K	>80	IP66	30°X50°, 50°, 70°, 80°, 85°	2,4kg
UTR1ST.20.051.8A5000	51	9250- 9800	5000K	>80	IP66	30°X50°, 50°, 70°, 80°, 85°	2,4kg









Ultra LED 1.0 3

UTR1ST.30.069.8A3000	69	11700- 12450	3000K	>80	IP66	30°X50°, 50°, 70°, 80°, 85°	2,4kg
UTR1ST.30.069.8A4000	69	12100 - 12850	4000K	>80	IP66	30°X50°, 50°, 70°, 80°, 85°	2,4kg
UTR1ST.30.069.8A5000	69	12150- 12900	5000K	>80	IP66	30°X50°, 50°, 70°, 80°, 85°	2,4kg









Ultra LED 1.0 4

		 min-max					
UTR1ST.40.084.8A3000	84	14800 - 15750	3000K	>80	IP66	30°X50°, 50°, 70°, 80°, 85°	3,4kg
UTR1ST.40.084.8A4000	84	15300 - 16250	4000K	>80	IP66	30°X50°, 50°, 70°, 80°, 85°	3,4kg
UTR1ST.40.084.8A5000	84	15350 - 16300	5000K	>80	IP66	30°X50°, 50°, 70°, 80°, 85°	3,4kg









Ultra LED 1.0 5

							
UTR1ST.50.103.8A3000	103	17850 - 19000	3000K	>80	IP66	30°X50°, 50°, 70°, 80°, 85°	3,4kg
UTR1ST.50.103.8A4000	103	18450 - 19600	4000K	>80	IP66	30°X50°, 50°, 70°, 80°, 85°	3,4kg
UTR1ST.50.103.8A5000	103	18500 - 19650	5000K	>80	IP66	30°X50°, 50°, 70°, 80°, 85°	3,4kg









Ultra LED 1.0 6

							
UTR1ST.60.117.8A3000	117	20950 - 22300	3000K	>80	IP66	30°X50°, 50°, 70°, 80°, 85°	4,4kg
UTR1ST.60.117.8A4000	117	21700 - 23050	4000K	>80	IP66	30°X50°, 50°, 70°, 80°, 85°	4,4kg
UTR1ST.60.117.8A5000	117	21750 - 23100	5000K	>80	IP66	30°X50°, 50°, 70°, 80°, 85°	4,4kg

Ultra LED 1.0 7

							
UTR1ST.70.135.8A3000	135	23600 - 25100	3000K	>80	IP66	30°X50°, 50°, 70°, 80°, 85°	4,4kg
UTR1ST.70.135.8A4000	135	24450 - 25950	4000K	>80	IP66	30°X50°, 50°, 70°, 80°, 85°	4,4kg
UTR1ST.70.135.8A5000	135	24500 - 26000	5000K	>80	IP66	30°X50°, 50°, 70°, 80°, 85°	4,4kg



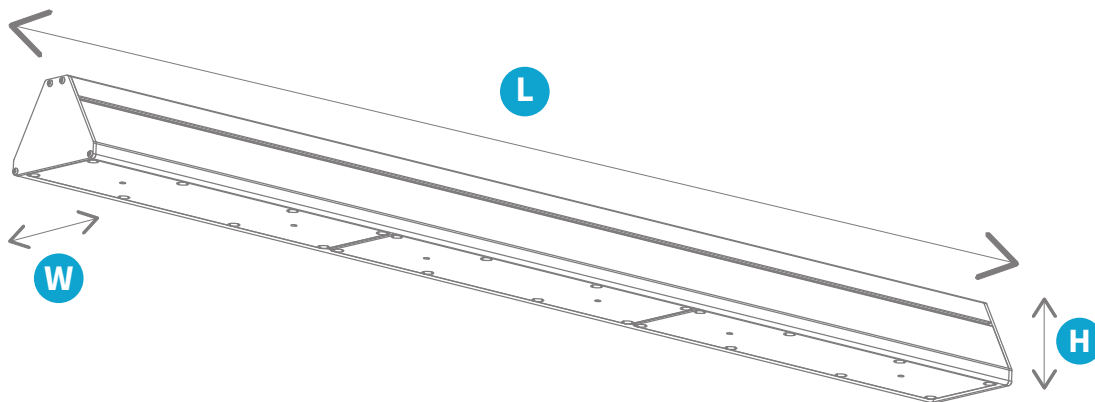

Ultra LED 1.0 8

							
UTR1ST.80.154.8A3000	154	26500 - 28150	3000K	>80	IP66	30°X50°, 50°, 70°, 80°, 85°	4,4kg
UTR1ST.80.154.8A4000	154	27400 - 29100	4000K	>80	IP66	30°X50°, 50°, 70°, 80°, 85°	4,4kg
UTR1ST.80.154.8A5000	154	27450 - 29150	5000K	>80	IP66	30°X50°, 50°, 70°, 80°, 85°	4,4kg
UTR1ST.80.173.8A3000	173	29300 - 31150	3000K	>80	IP66	30°X50°, 50°, 70°, 80°, 85°	4,4kg
UTR1ST.80.173.8A4000	173	30300 - 32200	4000K	>80	IP66	30°X50°, 50°, 70°, 80°, 85°	4,4kg
UTR1ST.80.173.8A5000	173	30350 - 32250	5000K	>80	IP66	30°X50°, 50°, 70°, 80°, 85°	4,4kg
UTR1ST.80.193.8A3000	193	32250 - 34250	3000K	>80	IP66	30°X50°, 50°, 70°, 80°, 85°	4,4kg
UTR1ST.80.193.8A4000	193	33350 - 35400	4000K	>80	IP66	30°X50°, 50°, 70°, 80°, 85°	4,4kg
UTR1ST.80.193.8A5000	193	33400 - 35450	5000K	>80	IP66	30°X50°, 50°, 70°, 80°, 85°	4,4kg
UTR1ST.80.210.8A3000	210	34350 - 36500	3000K	>80	IP66	30°X50°, 50°, 70°, 80°, 85°	4,4kg
UTR1ST.80.210.8A4000	210	35500 - 37700	4000K	>80	IP66	30°X50°, 50°, 70°, 80°, 85°	4,4kg
UTR1ST.80.210.8A5000	210	35550 - 37750	5000K	>80	IP66	30°X50°, 50°, 70°, 80°, 85°	4,4kg

Wymiarowanie i Logistyka



	H	L	W
UTR1ST.10	74	331	98
UTR1ST.20	74	652	98
UTR1ST.30	74	652	98
UTR1ST.40	74	975	98
UTR1ST.50	74	975	98
UTR1ST.60	74	1296	98
UTR1ST.70	74	1296	98
UTR1ST.80	74	1296	98

			
UTR1ST.10	4	64	120x80
UTR1ST.20	4	64	120x80
UTR1ST.30	4	64	120x80
UTR1ST.40	4	64	120x80
UTR1ST.50	4	64	120x80
UTR1ST.60	3	48	150x80
UTR1ST.70	3	48	150x80
UTR1ST.80	3	48	150x80

Montaż

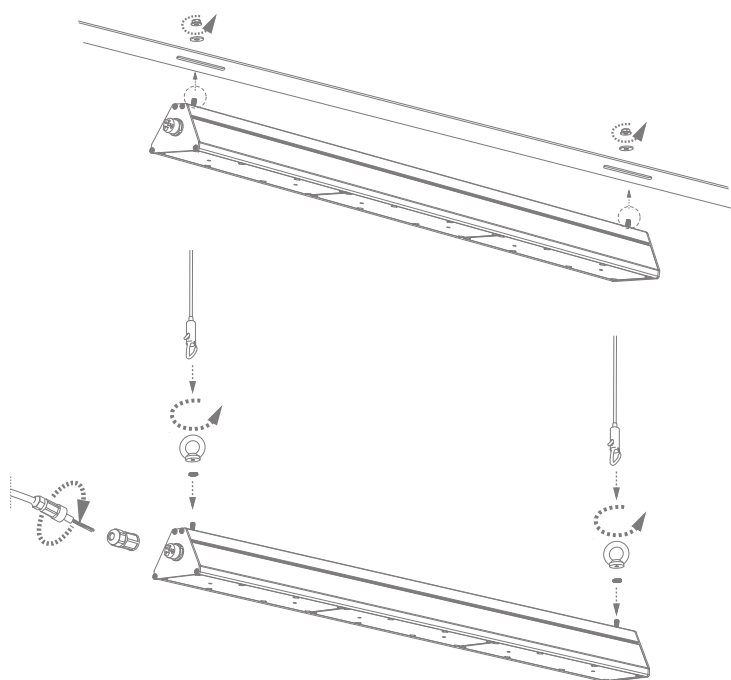

Montaż natynkowy

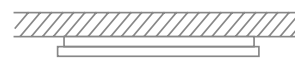

Montaż zwieszany



Rozsył Światłości

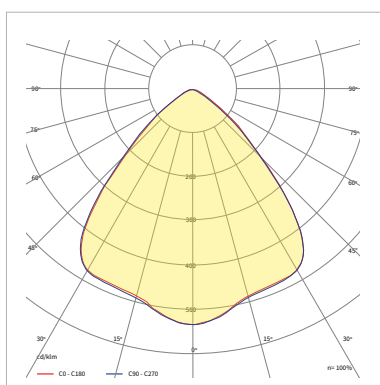
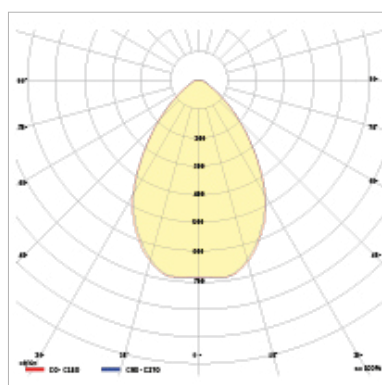
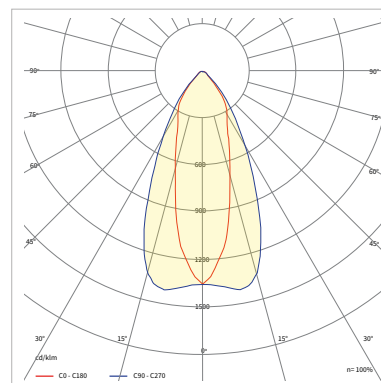
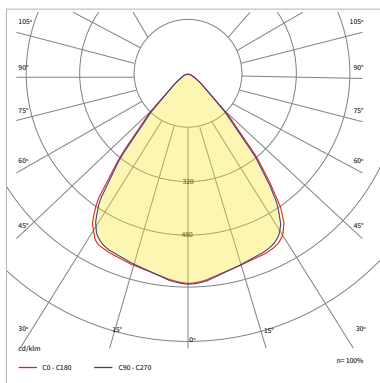
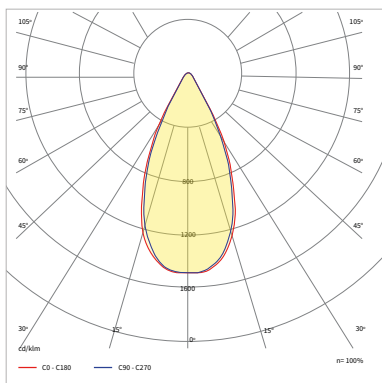

Dostępne konfiguracje

Rodzina	Wersja mocowa	Wersja	Moc [W]	CRI	Typ diody	CCT [K]	Materiał soczewki	Materiał dyfuzora	Rozsył	Sterowanie	Temperatury pracy [°C]	Gwarancja	Modyfikacje
UTR1ST ULTRA LED 1.0	1	0	035	8	A	3000	2	000	030050	00	2540	05Y	0000
	1	Standard	35W	>80	Mid Power	3000K	PC	Nie występuje	30x50	ON/OFF	-25+40	5 lat	Standard
	2		051			4000			050050	D0	2545	08Y	
	2		51W			4000K			95x95	Dali Przewodowe	-25+45	8 lat	
	3		069			5000			070070		2550	10Y	
	3		69W			5000K			70x70		-25+50	10 lat	
	4		084						080080		3545		
	4		84W						80x80		-35+45		
	5		103						085085		3550		
	5		103W						85x85		-35+50		
	6		117								3555		
	6		117W								-35+55		
	7		135								3560		
7		135W								-35+60			
8		154											
8		154W											
		173											
		173W											
		193											
		193W											
		210											
		210W											

Przykładowy kod produktu:

[UTR1ST.80.173.8A4000.2000.070070.00.3550.05Y.0000](#)