

OTe 25/220-240/700 CS

Constant Current LED Power Supply

500mA - 600mA - 700mA

OPTOTRONIC® LED Power Supply with high efficiency and reliability in small compact housing. Equips with 3 selectable currents functionality fits in light fixtures for office and shop lighting.

Benefits

Three fixed selectable output currents
Easy current selection
Long lasting and high reliability
Extra small compact housing

Applications

Downlights, Spotlights and other Indoor LED applications

Approval marks

Under preparation

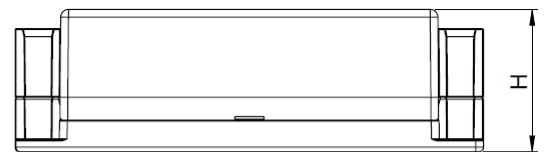
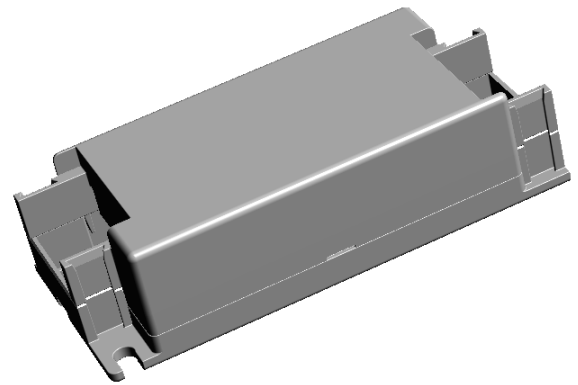

L	88mm
B	43mm
H	29.5 mm

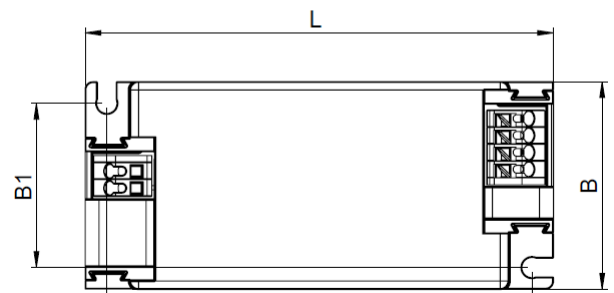
**Product Features**

- Output currents : 500/600/700mA
- Output voltage : 18V_{DC} – 36V_{DC}
- Output power : 9W - 25W
- Input voltage : 220 – 240 V_{AC}
- Typ. Efficiency : ≥85%
- Fixed Output (i.e. no dimming)
- Ambient temp range, t_a : -20°C to +50°C
- Max. case temperature at t_c point : 75°C
- Galvanic isolation : 3.75kVrms
- Optional cable clamp is available
- Suitable for class I and II luminaires
- 50'000 h lifetime at $t_c = 65^\circ\text{C}$

Electrical Specifications

	Item	Value	Unit	Remarks
INPUT	Nominal voltage	220 – 240	V _{AC}	
	Nominal frequency	50 - 60	Hz	
	AC voltage range	198 – 264	V _{AC}	Permitted voltage range
	DC voltage range	NA	V	
	Maximum voltage	275	V	2hrs
	Nominal current	160	mA	230V, Refer to Table 1 for details
	Total Harmonic Distortion (THD)	< 20	%	Full load, 230 V, 50 Hz / see graphs
	Power factor	> 0.95		Full load, 230 V, 50 Hz / see graphs
	Efficiency	> 85	%	Full load, 230 V, 50 Hz, typical / see graphs
	No-load power	< 1.5	W	230V, typical
	Stand-by power	NA	W	
	Power loss	4.4	W	at 230V, Input power 29.4 W max. Refer to Table 1 for details
	Protection class	II		Suitable for class I and class II luminaires
	Inrush current	<16	A	t _{width} = 100 µs typical (measured at 50% I _{peak})
	Max. units per circuit breaker	B16: 50; B10: 30		I _{max} = 53 A Th = 230 µs
Leakage current	< 0.5	mA	Output floating	
OUTPUT	Nominal voltage range	18 – 36	V _{DC}	Refer to Table 1 for details
	Maximum voltage	50	V _{DC}	Open circuit
	Nominal current range	500 / 600 /700	mA	
	Current accuracy	+/- 5	%	
	Current ripple	< 30	%	Ripple / average @ 100 Hz
	Nominal power range	9 – 25	W	Partial Load. Refer to Table 1 for details
	Maximum power	25	W	T _a ≤ 50°C, Refer to Table 1 for details
	Galvanic isolation	SELV-equivalent		3,75 kVrms . Output to mains - Touch current < 0.5 mA
DIMMING	Dimming control	No		Not dimmable
	Dimming range	NA	%	
	Dimming technique	NA		
	Frequency	NA	Hz	
	Galvanic isolation	NA		
ENVIRONMENT	Ambient temperature range t _a	-20 ...+50	°C	Refer to Table 1 for details
	Maximum case temperature t _c	75	°C	Measured on t _c point indicated of the product label. Refer to Table 1 for details
	Max. case temp. in fault condition	110	°C	
	Storage temperature range	-25 ...+75	°C	Cool down before operating
	Relative humidity	5 ... 85	%	Not condensing
	Surge transient protection	1 1	kV	L/N LN/PE acc. IEC 61000-3-2 (ANSI C62.41 Cat.A ...)
	Environmental rating	Indoor		
	IP rating	IP 20		
	Mains switching cycles	> 100'000		
	Expected lifetime	35'000 50'000	hrs	t _c = 75°C, 10% failure rate t _c = 65°C, 10% failure rate Refer to Table 2 for details

Protections

Overtemperature

Automatic, reversible

Overload

Automatic, reversible

No load

Yes

Short-circuit

Automatic, reversible

Input overvoltage

Maximum allowed input voltage 275V AC

Output overvoltage

Yes, Limitation of Output voltage < 60V

Output undervoltage

NA

LED load protection

NA

Wiring Diagram

Terminal:

Max. cable length - system:

Geometry (l x b x h):

Weight:

Push in terminals

2 m

97 x 43 x 29.5 mm

90 g

Wire preparation:

Push in

s:0.5-1.5

f:0.75-1.5

6.5-7.5mm

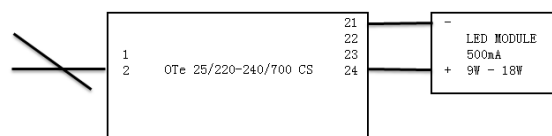

Example with 500mA LED module

Hot plug-in or secondary switching of LEDs is not permitted and may cause a very high current to the LEDs.

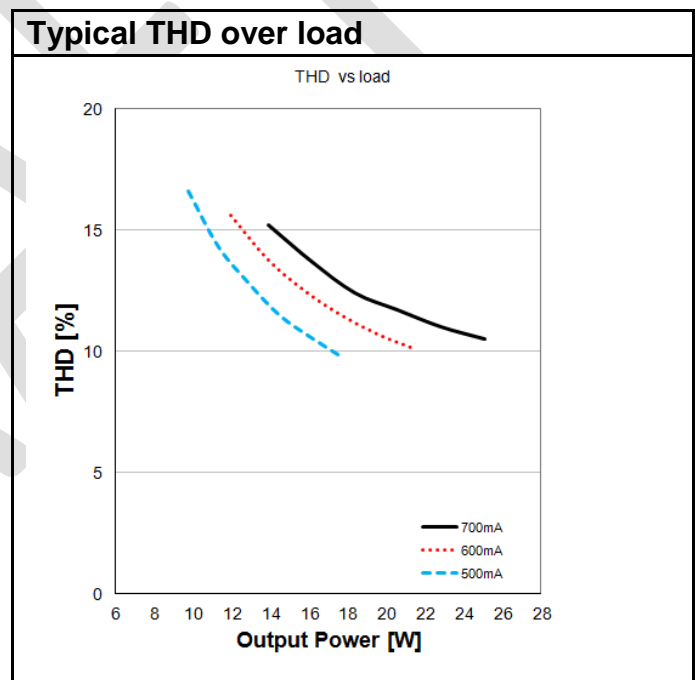
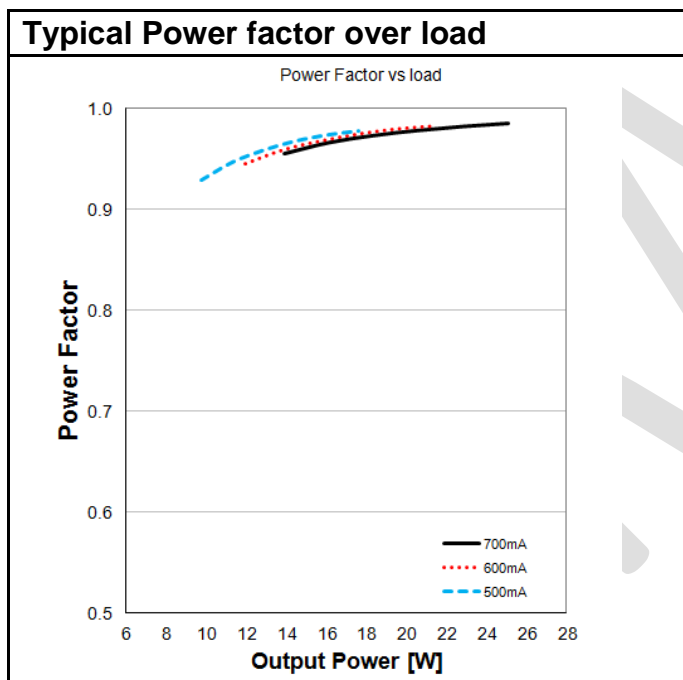
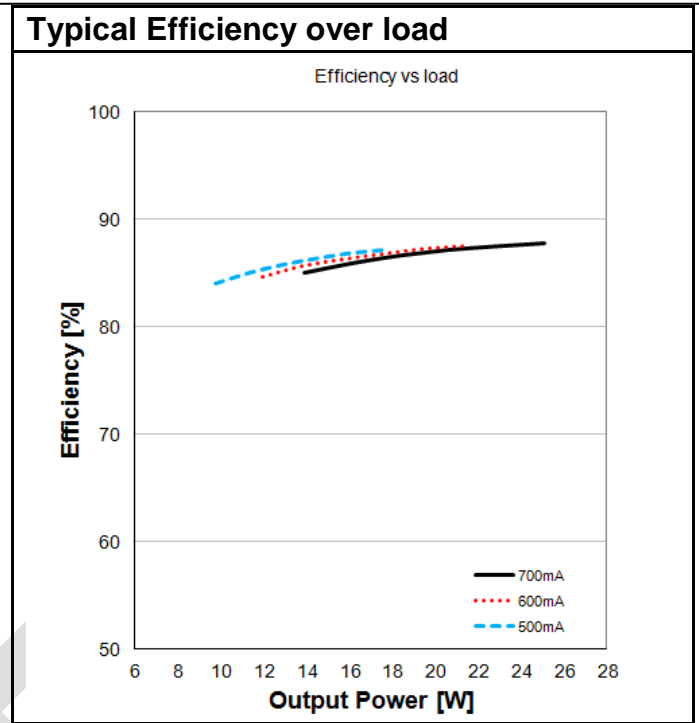
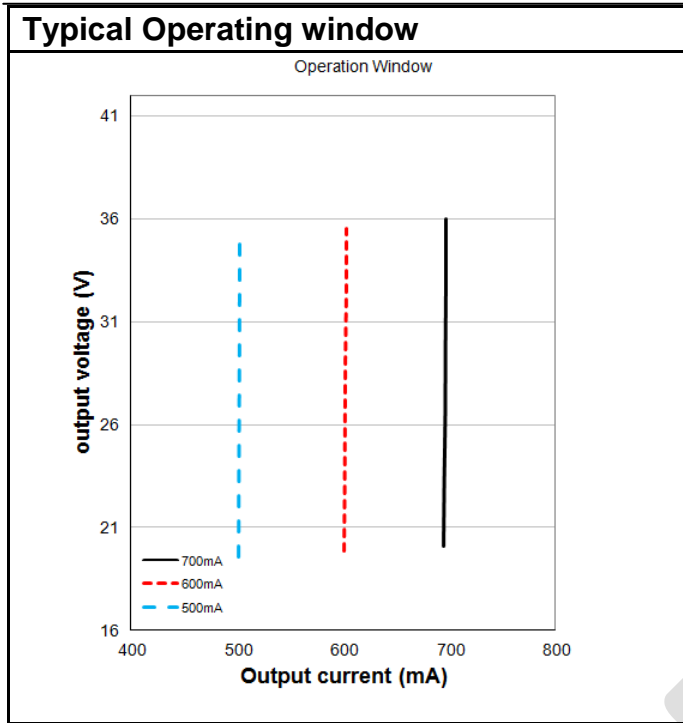

An optional cable clamp is available. This cable clamp can be snapped onto the ECG and thus converts it into an ECG suitable for independent installation.

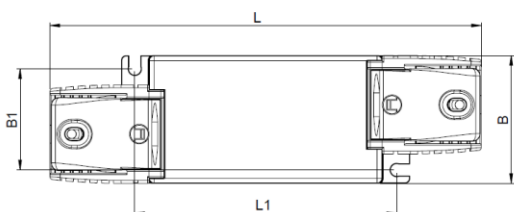

L	145mm
L1	88mm
B	43mm
B1	34mm
1	29.5mm

Table 1 - Rated output power and current sets

I_{out} (mA)	500	600	700
U min [V]	18	18	18
U max [V]	36	36	36
P min [W]	9	11	13
P max [W]	18	22	25
T_a [°C]	50	50	50
T_c [°C]	75	75	75
Line Current, nominal@230V mA	120	140	160
Max Power Loss@230V [W]	3.2	3.9	4.4
Input Power @230V [W]	21.2	25.9	29.4

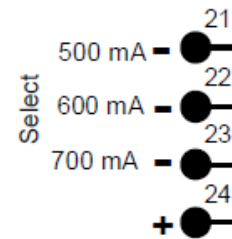

Current selection by connect to right terminal

Table 2 - Expected lifetime

T_a = 50°C , T_c [°C] , All I_{out}	65°C	75°C
Lifetime	50'000h	35'000h

Standards

Safety: IEC 61347-1, IEC 61347-2-13
 Performance: IEC 62384
 Radio interference: CISPR 15
 Harmonic content: IEC 61000-3-2
 Immunity: IEC 61000-3-3
 IEC 61547

Ordering information

Product name	Type	EAN10	EAN40	Pieces / box
OTe 25/220-240/420 CS	AA56805	4052899917538	4052899917590	20
OT Cable Clamp D-style	TBD	TBD	TBD	20

Disclaimer (Engineering Samples: B-Samples and C-Samples)

This product is a demonstration model from our development laboratories made available for your information only. The model is not binding in respect to its fitness for use, i.e. service life, luminous flux, color temperature and performance. Prior to production the design, including dimensions, is subject to modification. You will, therefore, appreciate that at this stage of development we are unable to assume any liability also for damages which may be caused by this product. Should you urgently require binding information for the preparation of construction data for your applications, please contact our marketing department.

Manufacturer's address:**OSRAM GmbH**

Steinerne Furt 62 D-86167 Augsburg
 Germany

www.osram.com

Technical support:

Kunden Service Center Germany
 +49 (0)89-6213-60 00